

AP TOOLS™

A **AUTOMOTIVE TOOLS**

S **SPECIALTY TOOLS**

I **INDUSTRIAL TOOLS**





 **AUTOMOTIVE TOOLS**

 **SPECIALTY TOOLS**

 **INDUSTRIAL TOOLS**

NEW TOOLS Space has been left on pages 37-39 for details of AP Tool new releases. Register now to receive up-dates of further new tool releases.
E-mail: sales@endeavourtools.com.au

Welcome to the **AP TOOLS** exciting range of quality tools.

AP TOOLS offers a comprehensive range of automotive, specialty and industrial tools to meet the demanding needs of today. Our range of innovative tools are designed to suit a wide variety of general as well as specific applications. Use the product index to find the tool you need, or see our new products section found at the rear of this catalogue.

AP TOOLS the perfect tools for all your needs.

ENDEAVOUR TOOLS PTY LTD

VICTORIA - Head Office
50 Jellico Drive
Scoresby VICTORIA 3179
Phone: (03) 9753 3800
Fax: (03) 9753 3933

SYDNEY
Suite 1 / Unit 2,
12-18 Victoria Street East
Lidcombe NSW 2141
Phone: (02) 9646 4222
Fax: (02) 9646 5399

from  **ENDEAVOUR TOOLS**

DA0068

Angle Tip Relay Pliers

The tool aids in the removal and installation of most types of vehicle relays. Those located in confined or difficult to reach areas. The pliers have specially coated tips giving a solid grip that's required when removing and installing relays.



List Price Ea. \$35.00
Excl. GST

DA1836

Cable Stripper

2 blades model for RG-58, 59, 62, 6, 3C, 4C, & 5C. Capacity 4.9mm diameter to 7.5mm diameter.

List Price Ea. \$20.00
Excl. GST



DA0153

Flat Nose Retaining Ring Plier

Max spread: 1-1/2" (38mm) Length: 9-1/4" (235mm)
Tips: Long, slim, straight with centering-rod



List Price Ea. \$32.00
Excl. GST

DA2899

Professional Snap Ring Plier Set

Retaining ring set, for internal and external use. Changeable alloy steel tips. Tempered steel professional circlip pliers set for internal & external use. Replaceable tips & spring ratchet locking mechanism to hold snap rings securely.

List Price Ea. \$87.00
Excl. GST



DA0187

Quick Change Windscreen Removal Tool

Remove windcreens fast, with the comfortable metal grip and pull handle.



List Price Ea. \$42.95
Excl. GST

DA3334

Plier - Assemble & Disassemble

Used with the drum brake parking lever



List Price Ea. \$44.00
Excl. GST

DA1426

Vehicle Light Tester (6 - 12 Volt)

Brass casting body with sharp probe tip covered with brass protection cap. Easily check vehicle lights.



DA3368

7pc Fan Clutch & Pulley Service Kit

Contents:
Mercedes Benz Fan Clutch Holder
Mercedes Benz Fan Belt Service Wrench
BMW Fan Clutch Holder
DA3388 BMW Fan Clutch Tool
DA3389 Mercedes Benz Fan Clutch Tool
DA3397 Mercedes Benz Fan Clutch Tool
DA3398 Mercedes Benz Fan Clutch Holder



List Price Ea. \$260.00
Excl. GST

DA1818

Battery Tool Kit

Contents:
5/16" Hex box side terminal battery wrench.
10mm Hex box side terminal battery wrench.
5/16" Hex box extra long side terminal battery wrench (9-3/4" long).
Side terminal battery brush. Angle battery nut plier. Battery terminal / bearing puller. Battery terminal cleaner.



List Price Ea. \$98.00
Excl. GST

DA1835

Cable Stripper

Insert flat cable to touch the length guide stopper (6mm/12mm). Squeeze the stripper then pull out flat cable. Insert UTP / STP, Coax, squeeze the stripper with thumb, turn the stripper forward and backward 2 times. Release the stripper to finish stripping.



List Price Ea. \$20.00
Excl. GST

DA3397

Mercedes Benz Fan Clutch Wrench

65mm opening. Replaces the fan clutch assembly on Mercedes-Benz vehicles. Slim handle helps work in hard to reach areas. For use on engines M103, M104, M119 & M120.



List Price Ea. \$78.00
Excl. GST

DA3398

Mercedes Benz Fan Clutch Holder

Designed with 3 special holes to hold the stud on the fan clutch assembly and allow release of lock nut. For use on Mercedes-Benz vehicles C & E class engines M111, OM604, OM605 & OM606.

List Price Ea. **\$70.00**
Excl. GST



DA5605

18pce Caliper Wind-Back Tool Kit

Kit includes 2 wind back forcing units, right and left hand, plus a selection of adaptors to suit most vehicles.

List Price Ea. **\$275.00**
Excl. GST



DA3889

Adjustable Wheel Lock Nut Wrench

Adjustable jaws with locking feature to suit both hexagon and octagon wheel bearing lock nuts. Includes set of three pins for lock nuts with pin holes.

List Price Ea. **\$395.00**
Excl. GST



DA6885

Deluxe Lockout Tool Set

The tools are for opening the doors of most vehicles. An instruction handbook is enclosed. All selected tools are carefully chosen to suit various applications and positions. Complete with sturdy fold up carry bag.

List Price Ea. **\$253.00**
Excl. GST



DA5215

6pce Mini Panel Removal Set

Great for removing small or fine facia trim and bezels from dashboards, air vents, door panels, and much more. Made from impact resistant high quality nylon.

List Price Ea. **\$40.00**
Excl. GST



DA6928

3pce Air Cushion Bag Set

Includes hand pump with a fine air control valve. The air bags are gentle on glass, frames and paintwork. Each bag is made from tough reinforced fabric. Bag sizes are 57 x 190mm, 60 x 180mm and 160 x 160mm.

List Price Ea. **\$80.00**
Excl. GST



DA5216

5pce Handy Removal Set

Designed for the removal of upholstery and trim. Contains five trim tools for angle, straight wide, narrow, forked and tapered applications. Made from impact resistant high quality nylon.

List Price Ea. **\$35.00**
Excl. GST



DA6992

4pce Super Scraper Set

For general scraping jobs. Can also be used as a stripping chisel. Great for removal of auto trim, badges or decals from bodywork. Durable red handles can be hit with a hammer. Sizes 3/4" (20mm), 7/8" (23mm), 1" (25mm) & 1-1/2" (38mm).

List Price Ea. **\$50.00**
Excl. GST

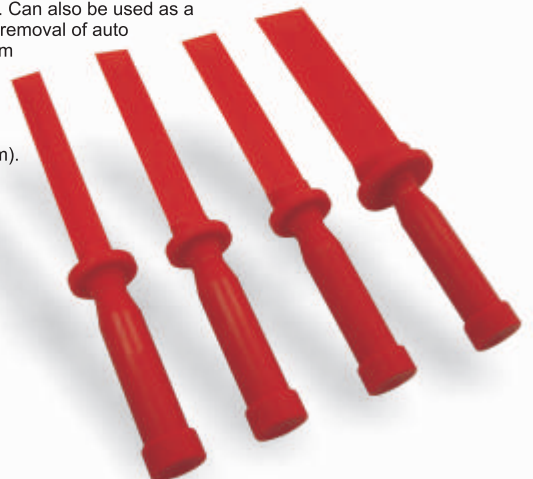

DA5556

Brake Caliper Piston Tool

Wind back disc brake pistons on Audi, Rover, Ford, Peugeot, VW, Nissan & Subaru vehicles.

List Price Ea. **\$52.00**
Excl. GST



DA7047

Pocket Magnetic Pick Up Tool

Stainless steel telescoping shaft. Extends from 7" to 30". This magnet is ringed with a flexible insulating sleeve to make it convenient to pick up items. Magnetic Capacity 3.6 kg



List Price Ea. \$20.00
Excl. GST

DA7387

3pce 1/2" Drive Long Deep Impact Socket Set

Deep sockets with plastic sleeve, to protect surrounding areas from damage. Socket sizes: 17, 19, 21mm, O.L.: 150mm



List Price Ea. \$95.00
Excl. GST

DA7391

15pce 3/8" Drive Crowfoot Wrench Set

Tempered forged alloy steel. Sizes: 10, 11, 12, 13, 14, 15, 16, 17, 18, 19, 21, 22, 23, 24 and 26mm



List Price Ea. \$101.00
Excl. GST

DA7393

14pce 1/2" Drive Crowfoot Wrench Set

Tempered forged alloy steel. Sizes: 27, 29, 30, 32, 33, 34, 35, 36, 38, 41, 43, 46, 48 and 50mm.



List Price Ea. \$260.00
Excl. GST

DA8991

BMW Master Timing Locking Tool Kit

Contents: BMW timing set-up bracket, BMW sprocket locking tool, crankshaft hub puller, air adaptor, chain tensioner locking pin, primary chain tensioner tool.

For Use with BMW M50, M52, M52TU, M54, M56 Double Vanos Engines.



List Price Ea. \$780.00
Excl. GST

HOT NEW Tool

DA9047

Fluid Line 4pce Clamp Set

This tool helps stop hose liquid flow without damaging the hose. Suits hose sizes: 10mm, 15mm, 25mm, 45mm.



List Price Ea. \$39.00
Excl. GST

DA9148

Tapered Reamer

Size: 5/32" to 7/8"



List Price Ea. \$80.00
Excl. GST

DA9190

Euro Door Hinge / Handle Kit

Includes carry case & 4 door hinge bits (less than 1 inch long) with slender ratchet wrench and extra long drivers for accessing Mercedes Benz and VW door handle fasteners.



List Price Ea. \$80.00
Excl. GST

DA9224

Mercedes Benz Rear Wheel Bearing Tool Kit

Used for removing the rear wheel bearing that's located in wheel carrier. This tool can also be used to install the rear axle shaft flange. Designed to suit Mercedes Benz models W210.



List Price Ea. \$600.00
Excl. GST

DA9262

BMW Master Camshaft Locking Tool Kit

Contents: BMW camshaft locking tool. Application BMW engine models: M40, M42, M43, M44, M50, M52, M52TU, M54, M60, M62, M70, M73, S50, S52 & S62

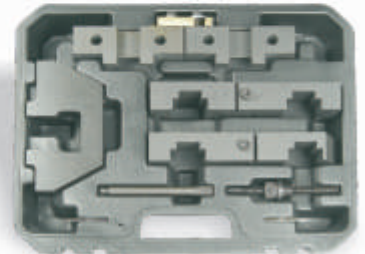

List Price Ea. \$760.00
Excl. GST



DA9333

46pc Master Radio Release Key Set

Set includes most radio release keys. Can be used on Mercedes Benz, BMW, VW, Audi, Ford, Opel, Skoda, Fiat Bravo, Brava, Porsche. Radio units, Sony 2001 & 2002, Panasonic, Kenwood 2002, Blaupunkt, Clarion, Pioneer & JVC.



List Price Ea. \$135.00
Excl. GST

DA9362

Cable Cutter

For cutting copper & aluminum cable up to 22mm². Overall Length: 165mm



List Price Ea. \$22.50
Excl. GST

DA9363

Cable Cutter

For cutting copper & aluminum cable up to 38mm².
Overall Length: 210mm

List Price Ea. **\$25.00**
Excl. GST



DA9459

Angle Tip Lock Ring Plier

Plier nose end width: 8.0mm
Overall Length: 220mm

List Price Ea. **\$47.00**
Excl. GST



DA9364

Cable Cutter

For cutting copper & aluminum cable up to 60mm².
Overall Length: 238mm

List Price Ea. **\$30.00**
Excl. GST



DA9474

7 in 1 Wire Stripper & Crimper

Plier nose. Wire stripper. Wire cutter.
Screw cutter. Insulated terminal
crimper. 7-8mm auto crimper.
All vehicles.

List Price Ea. **\$30.00**
Excl. GST



DA9369

Cable Cutter

For cutting copper and aluminum cable up to 100mm².
Overall Length: 315mm

List Price Ea. **\$120.00**
Excl. GST



DA9484

Wire Stripper

Plier nose. Wire stripper. Wire
cutter. All vehicles.

List Price Ea. **\$24.00**
Excl. GST



DA9370

Cable Cutter

For cutting copper and aluminum cable up to 150mm².
Overall Length: 420mm

List Price Ea. **\$130.00**
Excl. GST

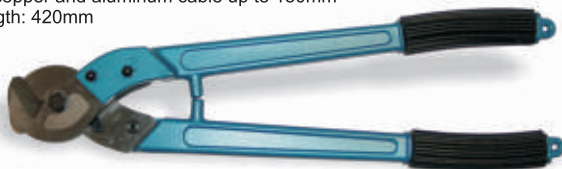

DA9660

Mercedes Benz Transmission Dipstick

This tool is designed to measure the oil level of
the transmission.
Overall Length: 1220mm
Application: Type 722.6 transmission

List Price Ea. **\$50.00**
Excl. GST



DA9371

Cable Cutter

For cutting copper and aluminum cable up to 250mm².
Overall Length: 600mm

List Price Ea. **\$120.00**
Excl. GST



DA9661

Mercedes Benz Transmission Dipstick

This tool is designed to measure the oil level of
the transmission.
Overall Length: 920mm
Application: Type 722.7 & 716.5 transmissions

List Price Ea. **\$45.00**
Excl. GST



DA9372

Cable Cutter

For cutting copper and aluminum cable up to 400mm².
Overall Length: 700mm

List Price Ea. **\$140.00**
Excl. GST

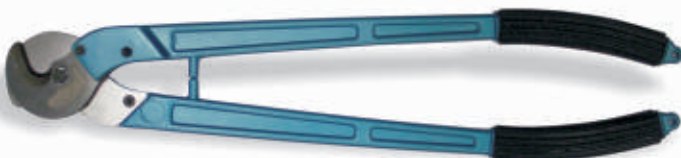

DA9989

Hose Clamp Kit

Contains six different styles of
hose clamp pliers, which will
service most flat-band and right-style
hose clamp. Also contains a hose
removal tool. Contents:
DA0144 HOSE CLAMP PLIERS.
DA1414 HOSE REMOVER.
DA3045 FLEXIBLE HOSE CLAMP PLIER.
DA3333 MULTI-PURPOSE HOSE & WIRE PLIERS.
DA3344 2PC UNIVERSAL HOSE CLAMP PLIER SET.
DA6627 HOSE REMOVER PLIER.

List Price Ea. **\$225.00**
Excl. GST



A	page
A/C & Fuel Line Spring Lock Coupling Tool	14
A/C Fuel Line Disconnect Tool Set	12
Adjustable Oil Filter Wrench	23
AF Clutch Alignment Tool	32
Alternator / Battery Tester	8
Angle Gauge Torque	29
Antenna Socket Set	15
Arm Puller - Pitman	17
Auto Computer Memory Tool	30
Aviation Snips	35
Axle Nut 4WD Impact Socket 36mm	18
Axle Rear - Puller Plate	15
Axle Rear Bearing - Puller Set	15
Axle Rear Flange Nut Socket	18

B	page
Balancer Installer - Harmonic	32
Balancer, Puller & Installer	32
Ball Joint / Tie Rod Remover	17
Ball Joint	14-18
Band-Type CV Boot Clamp Tool	25
Band-Type Oil Filter Wrench	23-24
Battery / Alternator Tester	8
Battery Carrier	6
Battery Filler	1
Battery Terminal Cleaner	6
Bearing Cup Remover	14
Bearing Packers	30
Bearing Puller Kit Hydraulic	18
Bearing Puller Pilot	15
Bearing Race & Seal Drive Kits	33
Bearing Separators	16
Bendix Brake Spring Tool	20
Bit Set Mechanics	7-8
Bit Set Torx® Tamperproof	6
Boot Plier - Spark Plug	8
Boot Puller - Spark Plug	7
Bracing Tool Pulley	32
Brake & Fluid Hose Clamp	30
Brake Adjusting Tool	20
Brake Bleeder Hose	21
Brake Bleeder Kit	21
Brake Bleeding / Vacuum Pump Kit	21
Brake Calliper Wind-back Tool Kit	21
Brake Return Spring Tool	20
Brake Rivet Tool Kit	16
Brake Shoe Spring Tool	20
Brake Spoon	20
Brake Spring Compressor	20
Brake Spring Pliers	20
Brake Spring Tool Bendix	20
Brake Spring Washer Tool	20
Breaker Bars Extra Long	3
Brush Parts Cleaning	2
Brush Sets Cleaning	1-2
Bushing Extractors	33
Bushing Set	32

C	page
Cam-Type Oil Filter Wrench	23
Car Cord Tester	9
Car Light Tester 6 to 24 Volt	8
Carburettor Adjusting Tool	19
Carburettor Main Jet Tool Kit	19
Carburettor Service Kit - Rochester	19
Carrier Battery	6
Chain - Engine Lifting	13
Chain Oil Filter Wrench	23-24
Chain Type Oil Filter Wrench	24
Chisel & Punch Set	37
Chisel Holder & Punch	31
Circlip Pliers	9-10
Circlip Pliers Quick Change	10
Circuit Testers	7-9
Clamp Valve Spring	17
Clamp Wrench Offset Distributor	19
Cleaning Brush Set	1-2
Clincher-Type Oil Filter Wrench	23
Clip & Spring Removers	25-26
Clutch Alignment Tool	32-33
Clutch Fan Holder	13
Coil Spring - Compressor Set	17
Compact Compression Tester	32
Compression Tester	31-32
Compressor - OHC Valve Spring	11
Compressor - Piston Ring	11
Compressor - Universal Valve Spring	12
Compressor - Valve Spring	11
Compressor - Wrinkle Band Ring	11
Compressor Set - Coil Spring	17
Compressor Set - Piston Ring	11
Compressor Spring - Double Socket Valve	11
Computer - Safe Circuit Tester	8
Computer Auto Memory Tool	30
Continuity Tester	7
Coupler Tool Ford / GM Quick Disconnect	14
Coupling Tool Fuel Line & A/C Spring Lock	14
Crimping Tool Ratchet	34
CV Boot Clamp Plier Ear-Type	25
CV Boot Clamp Tool Band-Type	25
CV Joint Inner - Puller	15
Cylinder Hone Brake 2 & 3 Leg	21

D	page
Dead Blow Hammers	33
Disc Brake Pad Spreader	20
Disc Brake Piston Spreader	20
Disc Brake Piston Tool	19
Disconnect Coupler Tool Ford / GM	14
Disconnect Tool Set Fuel Line & A/C	12-14
Distributor Offset Clamp Wrench	19
Door Handle Clip Remover	26
Door Pin Extractor	26
Door Trim & Windshield Tool	26
Double Action Vacuum Lifter	25
Double Flaring Tool Kit	16

Double Point Scriber	4
Double Socket Valve - Compressor Spring	11
Dowel Pin Puller Set	19
Drain Plug Key Set Dual End	22
Drain Plug Wrench Set	22
Drift / Pin Brass Punch	31
Driver - Quarter Turn	34
Driver Kit - Seal	33
Dual Drive Oil Filter Wrench	24

E page

E Socket & Bit Set Torx®	6
Ear-Type CV Boot Clamp Plier	25
E-Clip Tool Set	12
Economic Oil Filter Wrench	24
Electronic Stethoscope	35
Engine Lifting Chain	13
Engineers Scriber	5
Extension Torque Bar Set	28
Extension Torque Bars	29
Extractor Door Pin Kit	26
Extractor Screw Kit	33
Extractor Screw Set	4
Extractor Set Multi-Spline	5
Extractors Bushing	33

F page

Fan Assembly Tool Viscous	13
Fan Belt - Hook Tool	12
Fan Clutch Holder	13
Fan Clutch Wrench	12
Fan Nut Wrench	13
Feeler Gauge	6
Filler Application Set	25
Fire Lock Wrench	2
Flare Nut Spanners	28
Flaring Tool Kit - Double	16
Flaring Tool Set	14
Flex-Drive Compression Tester	32
Flexible Handle	3
Flexible Pick-Up Tool	27
Ford / GM Quick Disconnect Coupler Tool	14
Freeze Plug Puller	14
Fuel & Vacuum Pump Tester	32
Fuel Line & A/C Spring Lock Coupling Tool	14
Fuel Line A/C Disconnect Tool	12-14
Fuel System Service Kit	19

G page

Gapper & Gauge Spark Plug	6
Gasket Scraper	5
Gauge & Gapper Spark Plug	6
Gauge Set - Screw Pitch	5
Gear Box Stop-Off Tool	30
Gear Puller 2 Jaws	16
Gear Puller Set Professional	17
Gland Nut Wrench	19
Grease Gun	1

Groove Cleaners - Piston Ring	10
Groove Joint Pliers	34

H page

Hammer Dead Blow	33
Hammer Set Lead More Interchangeable	37
Hand Drill & Speed Screwdriver	36
Hand Punch Set	4
Hands-Free Work Light	33
Harmonic Balancer Installer	32
Heavy Duty Chain Filter Wrench	23-24
Heavy Duty Hose Pinch Plier Set	30
Heavy Duty Oil Filter Wrench	24-25
Heavy Duty Socket Drive Chain Filter Wrench	24
High Tension System Tester	6
Hook & Pick Set	4
Hook & Scraper Set	4
Hook Tool - Fan Belt	12
Hose Clamp - Brake & Fluid	30
Hose Clamp Pliers	12
Hose Pinch Pliers	30
Hose Pinch-Off Tool Hydraulic	30
Hub Separator Universal	18
Hydraulic Bearing Puller Kit	18
Hydraulic Puller Set	15
Hydraulic Valve Lifter Puller	13

I page

Idle Screw Adjuster - Rochester Varajet Mikun Solexi	19
Impact Driver Set Professional	37
In-line Tester Spark	6
Installer Set & Pulley Puller	32
Insulated Screwdriver Set	36
Interchangeable Lead More Hammer Set	37

K page

Key Set Folding Type Torx®	8
Key Set Torx® Tamperproof	8
Knife Scraper - Multipurpose	5

L page

Lead More Interchangeable Hammer Set	37
Lead Puller - Spark Plug	7
Lock Nut Socket - Truck Wheel Bearing	9
Lock Ring Pliers	10
Lockout Tool Universal	25
Long Range Circuit Tester	9
Low Voltage Tester	9

M page

Magnetic Pick-Up Tools	27
Magnetic Screwdriver & Retriever	35
Magnetic Stainless Steel Tray	33
Magnifier With Tweezer	28
Main Jet Tool Kit Carburettor	19
Main Seal Tool - Rear	3
Master Wheel Wrench	13
Mat, Non-slip	1

Mechanics Bit Set	7
Mechanics Stethoscope	35
Metal Bearing Packer	30
Micro Adjustable Filter Wrench	23
Mirrors - Telescopic, Pick-Up Tool, Inspection	27-28
Motorcycle Oil Filter Wrench	22
Multi - Voltage Tester	9
Multi-Function Screwdriver	36
Multi-Spline Extractor Set	5

N page

Noid Lights	1
Non-Slip Mat	1
Nut Driver Set	36
Nut Splitters	4
Nut Wrench Set - Thermo Viscous Fan	12

O page

Offset Distributor Clamp Wrench	19
Oil Filter Plier	22-24
Oil Filter Ratchet Wrench	23
Oil Filter Wrench	22-25
Oil Filter Wrench - Chain Type	23-24
Oil Filter Wrench - Clincher Type	23
Oil Filter Wrench - Motorcycle	22
Oil Filter Wrench 3 Leg	22
Oil Filter Wrench Adjustable	23
Oil Filter Wrench Band Type	23-24
Oil Filter Wrench Cam-Type	23
Oil Filter Wrench Dual Drive	24
Oil Filter Wrench Micro Adjustable	23
Oil Filter Wrench Strap Type	23-24
Oil Filter Wrench Super-Grip Adjustable	24
Oil Pressure Socket	19
Oil Pressure Switch Tool	18
O-Ring Assortment Kit	37
Oxygen Sensor Socket	18

P page

Pad Spreader Disc Brake	20
Paint Strainer	37
Panel Crimper Pneumatic	34
Parts Cleaning Brush, Plastic Handle	2
Pedal Depressor Kit & Steering Wheel Holder	32
Pick & Hook Set	4
Pick-Up Tools	27
Pilot Bearing Puller	15
Pin / Drift Brass Punch Set	31
Piston Cube - Rear Disc Brake	21
Piston Ring - Compressor	11
Piston Ring - Pliers	10
Piston Ring Automatic Pliers	11-12
Piston Ring Groove Cleaners	10
Piston Spreader Disc Brake	20
Pitman Arm Puller	17
Plastic Funnel with Strainer	1
Plier - Hose Clamp	12
Plier - Wheel Weight	13

Plier Circlip	10
Plier Narrow Jaw - Hose Clamp	12
Plier Oil Filter	22 & 24
Plier Set Hose Clamp Universal	12
Plier Snap Ring - External	10
Plier Terminal Spark Plug	7
Plier Wire - Spark Plug	7
Pliers	34-35
Pliers - Automatic Piston Ring	11-12
Pliers - Piston Ring	10
Pliers Brake Spring	20
Pliers Circlip	9
Pliers Circlip Quick Change	10
Pliers Flat Band - Hose Clamp	12
Pliers Industrial Groove Joint	34
Pliers Lock Ring	10
Plug Hole Thread Chaser	7
Plug Puller - Freeze / Welsh	14
Pneumatic Panel Crimper	34
Pocket Telescopic Inspection Mirror	28
Power Steering Pump Puller Kit	32
Pressure Tester - Radiator	1
Professional Gear Puller Set	17
Professional Impact Driver Set	37
Pry Bars	4
Puller Hydraulic Valve Lifter	13
Puller Kit - Power Steering Pump	32
Puller Seal Heavy Duty	4
Puller Stud Kit - Metric	5
Puller Stud Kit - SAE	4
Puller, Balancer & Installer	32
Puller, Timing Gear	1
Pullers	15-19
Pulley Bracing Tool	32
Pulley Puller & Installer Set	32
Pull-Rod Set Auto Body	27
Pump Puller Power Steering Kit	32
Pump Tester Vacuum & Fuel	32
Punch & Chisel Holder	31
Punch & Chisel Set	37
Punch Set Hand	4
Punch Sets	31

Q page

Quarter Turn Driver	34
Quick Change Circlip Pliers	10

R page

Radiator Fin Tool	14
Radiator Tank Pressure Tester	1
Ratchet / Flex Handle 1/2" Drive	2
Ratchet Crimping Tool	34
Ratchet Handle	29
Ratchet Oil Filter Wrench	23
Razor Blades	5
Razor Scrapers	5
Rear Axle Flange Nut Socket	18
Rear Disc Brake Piston Cube	21

Rear Main Seal Tool	3
Rochester 4 Barrel Carburettor Service Kit	19
Rochester Varajet Mikuni Solex Idle Screw Adjuster	19

S	page
Safety Wire Twist Pliers	34
Sanding Blocks	25
Scraper & Hook Set	4
Scrapers	5
Screw Extractor Kit	33
Screw Extractor Sets	4
Screw Pitch Gauge Set	5
Screw Remover Sets	34
Screwdrivers	35-37
Scribers	4-5
Seal Drive & Bearing Race Kits	33
Seal Driver Kit	33
Seal Kit - Hydraulic Ram	15
Seal Puller - Valve Stem	10
Seal Puller Heavy Duty	4
Separator Ball Joint	14-18
Service Kits Ball Joint	18
Service Kits Spark Plug	2-3
Setter & Stud Remover Kits	19
Slide Hammers	15-17
Small Tail Pipe Expander	21
Snap Ring Plier - External	10
Socket & Bit Set E Torx®	6
Socket & Screwdriver Set	36
Socket 36mm 4WD Axle Nut Impact	18
Socket Antenna Set	15
Socket Drive Chain Filter Wrench	23
Socket Drive Chain Oil Filter Wrench	24
Socket Extra Long - Spark Plug	8
Socket Lock Nut - Truck Wheel Bearing	9
Socket Oil Pressure	19
Socket Oxygen Sensor	18
Socket Rear Axle Flange Nut	18
Socket Set E Torx®	6
Socket Set Spark Plug	2
Socket Special Set	15
Socket Vacuum Switch	18
Socket Valve Double - Compressor Spring	11
Socket Wrench T-Handle	2
Sockets Spark Plug	3
Spanner Flare Nut	28
Spanner Racks	34
Spanners - see Wrenches	
Spare Wicks For Puncture Plug Kit	13
Spark Plug - Boot Puller	7
Spark Plug - Extra Long Socket	8
Spark Plug - Lead Puller	7
Spark Plug - Wire Plier	7
Spark Plug - Wire Tester	7
Spark Plug Boot Plier - Heavy Duty	8
Spark Plug Firing Tester - Heavy Duty	8
Spark Plug Gauge & Gapper	6
Spark Plug Service Kits	2-3

Spark Plug Socket Sets	2
Spark Plug Sockets	3
Spark Plug Terminal Plier	7
Spark Plug Wrench T-Handle	3
Spark Tester In-line	6
Spline Extractor Set	5
Spot Weld Replacement Blades	27
Spot-Weld Cutters	26
Spray Nozzle Needle Windscreen	27
Spring Lock Coupling Tool Fuel Line & A/C	14
Steering Wheel - Puller Kit	16
Steering Wheel Holder & Pedal Depressor Kit	32
Stethoscope Electronic	35
Stethoscope Mechanics	35
Stop-Off Tool Gear Box	30
Straight Cut Aviation Snips	35
Strainer - Plastic Funnel	1
Stripping Tool Weather	25
Stubby Screwdriver Set	36
Stubby Wrench Sets	28
Stud Puller Kits	4-5
Stud Remover & Setter Kits	19
Suction Cup Vacuum	25
Switch Tool	18
Switch Tool Oil Pressure	18

T	page
Tail Pipe Expander	21-22
Tamperproof Bit Set Torx®	6
Tamperproof Torx® Key Set	8
Tape Measure	30
Telescopic Inspection Mirror	28
Telescopic, Magnetic, Pick-Up Tool, Needle	27
Terminal Brush - Battery	6
Terminal Cleaner - Battery	6
Terminal Spark Plug Plier	7
Tester - Circuit 3 to 48 Volts	9
Tester - Continuity	7
Tester - High Tension System	6
Tester Car Cord	9
Tester Car Light 6 to 24 Volt	8
Tester Circuit	7-9
Tester Firing - Spark Plug	8
Tester Spark In-line	6
Tester Voltage	7 & 9
T-handle 13/16" (21mm) Spark Plug Wrench	3
T-Handle Screwdriver	36
T-Handle Socket Wrench	2
T-Handle Spark Plug Wrench 13/16"	3
T-Handle Spark Plug Wrench 5/8"	3
T-handles	3
Thermo Viscous Fan - Nut Wrench Set	12
Thread Chaser - Plug Hole	7
Thread Restorer Set	1
Tie Rod / Ball Joint Remover Kit	17
Tie Rod End Tool Universal	17
Tie Rod Separator	17
Tie Rod Tool Universal	18

Torque Angle Gauge	29
Torque Extension Bars	28-29
Torque Wrench	29
Torx® Folding Key Set	8
Torx® Tamperproof Key Set	8
Torx® Wrench Set	8
Torx® Tamperproof Bit Set	6
Torx® E Socket & Bit Set	6
Torx® E Socket Set	6
Tray 6" Magnetic Stainless Steel	33
Tray Magnetic Stainless Steel	33
Trim Tool	21
Truck Bearing Packer	30
Truck Wheel - Lock Nut Socket	9
Tube Bender Precision	14
Tube Cutters	14
Tweezer with Magnifier	28
Tyre Repair Tool Kit	13
Tyre Valve - Core Set	13
Tyre Valve Installer	13

V page

Vacuum & Fuel Pump Tester	32
Vacuum Lifter Double Action	25
Vacuum Pump / Brake Bleeding Kit	21
Vacuum Suction Cup	25
Vacuum Switch Socket	18
Valve Air hold - Flexible	10
Valve Collet Replacer	10
Valve Core Set - Tyre	13
Valve Installer - Tyre	13
Valve Lappers	11
Valve Lifter Puller Hydraulic	13
Valve Spring - Compressor	11
Valve Spring Clamp	17
Valve Spring OHC - Compressor	11
Valve Spring Universal - Compressor	12
Valve Stem Repair Tool	13
Valve Stem Seal Plier	10
Viscous Fan Nut Wrenches	13
Viscous Fan Assembly Tool	13
Voltage Tester - High / Low	7

W page

Weather Stripping Tool	25
Wheel Weight Plier	13
Wheel Wrench	13
Wicks Spares for Puncture Plug Kit	13
Windscreen Spray Nozzle Needle	27
Windshield & Door Trim Tool Set	26
Windshield Locking Strip Tool	26
Windshield Moulding & Door Handle Clip Tool	26
Windshield Remover	26
Windshield Remover Wire-Type	26
Wire Plier - Spark Plug	7
Wire Tester - Spark Plug	7
Wire Twist Plier Safety	34
Wire-Type Windshield Remover	26

Work Light Hands-Free	33
Wrench - Fan Clutch	12
Wrench - Fan Nuts	13
Wrench Fire Lock	2
Wrench Gland Nut	19
Wrench Offset Distributor Clamp	19
Wrench Racks	34
Wrench Set Metric Stubby	28
Wrench Set Imperial Stubby	28
Wrench Set Flare Nut	28
Wrench Set Flare Nut	28
Wrench Set Torx®	8
Wrench T-Handle Socket	2
Wrench T-Handle Spark Plug	3
Wrenches Oil Filter - see Oil Filters	
Wrenches Torque - see Torque Wrench	
Wrinkle Band Ring - Compressor	11

NEW TOOLS

Space has been left on pages 37-39 for details of AP Tool new releases. Register now to receive up-dates of further new tool releases. E-mail: sales@endeavourtools.com.au



DA0045

Mat, Non-slip 45cm x 195cm

Multi-purpose non-slip mat. Great for tool boxes, car boots, boats, home and factory.



DA0060

Mat, Non-slip 60cm x 195cm

Multi-purpose non-slip mat. Great for tool boxes, car boots, boats, home and factory.



DA0071

Grease Gun

Loads 3 ways. Standard 16 oz, 450c.c, cartridge and pressure filler and bulk 500c.c.



DA0097

Plastic Funnel with Strainer

Durable plastic funnel with strainer. O.D. Funnel opening 150mm. Includes two spouts.



DA0098

Battery Filler

2 litre capacity, high temperature resistant. The hydrostatic valve shuts off automatically thus preventing overfilling and keeps out dirt.

DA0098-NOZ
Spare nozzle to suit the DA0098 Battery Filler.



DA0160

Noid Light Set

The most economical way to check electronic fuel injection (EFI) signals. Fast & easy checks for systems of GM TBI, Bosch PFI, Ford TBI, GM PFI, Geo TBI & GM SCPI. Disconnect fuel injectors, plug the noid light into injector wing harness then crank the engine.



DA0161

Noid Light , Bosch PFI

For checking EFI signals. Bosch PFI noid light.



DA0218

Deluxe Radiator Tank Pressure Tester

Traditional-style testing kit with adaptors. Locate system leaks from: head gasket, header tank, radiator & feeder core, core plugs and housing, water pumps, hoses. Suitable for: Audi, BMW, Citroen, Fiat, Ford, GM (Vauxhall/Opel), Peugeot, Volvo, Volkswagen and Japanese car series.



DA0295

Universal Thread Restorer Set

Covers thread sizes is SAE 4, 5, 6, 7, 7.5, 8, 9, 10, 11, 11.5, 12, 14, 16, 18, 20 & 24 tpi. Metric 1.0 1.25 1.5 1.75 2.0 2.5 3.0 & 4.0mm. Capacity from 1-1/4" to 5" (30mm-130mm) O.D.



DA1101

Cleaning Brush Set, Nylon

190mm steel handle. Nylon bristles. Consists of a curved and straight brush. Ideal for cleaning hard to reach areas.



Metal Cleaning Brush Sets

190mm steel handles. Consists of a curved and straight brush. Ideal for cleaning parts, rust and those hard to reach areas.

DA1102

Cleaning Brush Set, Brass



DA1103

Cleaning Brush Set, Steel



DA1104

Cleaning Brush Set, Stainless Steel



DA1130

Cleaning Brush Set, 3 pce

Contains brushes with nylon, brass and stainless steel bristles. Ideal for cleaning dirt, rust, peeled paint, including carburetors or distributors.



DA1132

Parts Cleaning Brush, Plastic Handle

Durable nylon bristles, can be used with general cleaning solvents. An excellent brush for cleaning engine parts.



Spark Plug Socket 2pce Sets

Magnetic insert holds spark plugs securely. Double hex chrome vanadium steel sockets in sizes 5/8" (16mm) & 13/16" (21mm). Universal joint allows for easy replacement of recessed spark plugs.

DA1166

3/8" Drive Set



DA1167

1/2" Drive Set

DA1168

Spark Plug Socket Set 1/2" Drive

Single hex chrome vanadium steel spark plug sockets in sizes 5/8" (16mm) & 13/16" (21mm). Universal joint allows for easy replacement of recessed spark plugs.



DA1170

Spark Plug Service Kit

Change or maintain spark plugs with this kit. Includes 2 spark plug sockets, 1 flexible joint T-handle, 1 gap setting tool & 1 wire brush.



T-Handle Socket Wrenches

Made from drop forged & heat treated chrome vanadium steel.

DA1171

Socket 8mm

DA1172

Socket 9mm

DA1173

Socket 10mm

DA1174

Socket 11mm

DA1175

Socket 12mm

DA1176

Socket 13mm

DA1177

Socket 14mm

DA1178

Socket 17mm

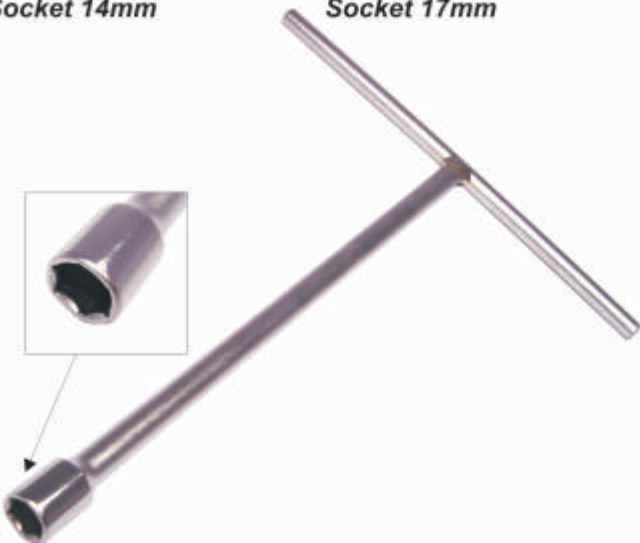

DA1179

Fire Lock Wrench

2 in 1 fire lock wrench 9/16" x 3/4" opening, 6 point. Drop forged alloy steel & heat treated.



DA1180

Ratchet / Flex Handle 1/2" Drive

Quick release design for easy assembly of ratchet head or flexible head. 1/2" square drive, handle extends from 12" to 24". Heavy duty strong construction, easy storage, ideal for tough jobs.



Spark Plug Sockets 3/8" Drive

Heat treated chrome vanadium steel socket with built in strong magnetic insert.

DA1181

5/8"

DA1182

18mm

DA1183

13/16"



DA1184

Spark Plug 4pc Service Kit

Includes 5/8" (16mm) & 13/16" (21mm) magnetic spark plug sockets, plus 1/2" drive 5" & 10" lock-on extension bars.



DA1186

Spark Plug Wrench Flexible T-handle 13/16" (21mm)

9" long T-handle for hard to reach recessed spark plugs. Flexible head with spring gives steady flexibility. Handle coated with PVC for comfortable grip.



DA1188

T-handle Long 1/2" Drive

17" extra long handle reaches deep inside hard to reach areas. PVC coated handle for better grip.



DA1189

Breaker Bar 3/4" Drive 25" Extra Long

Drop forged alloy steel, square drive swivels 180 degrees. Strong chrome vanadium steel handle for any tough job.



DA1190

Spark Plug 5pc Service Kit

Includes 3 extension bars 3", 6" & 10" lock-on type. 3/8" drive 5/8" (16mm) & 13/16" (21mm) magnetic spark plug sockets.



DA1191

Spark Plug 5/8" Socket 1/2" Drive

Heat treated chrome vanadium steel socket with built in strong magnetic insert.



DA1203

T-handle Long 3/8" Drive

17" extra long handle reaches deep inside hard to reach areas. PVC coated handle for better grip.



DA1207

Breaker Bar 1/2" Drive 24" Extra Long

Forged steel square drive swivels 180 degrees. Strong chrome vanadium steel handle for any tough job.

DA1207H
Replacement head for DA1207 breaker bar.



DA1208

T-handle - 18" Flexible 3/8" Drive

PVC coated handle, universal joint with 3/8" square drive. Extra long 18" OL for those hard to reach places.



Spark Plug Wrench T-Handle

9" long T-handle, heat treated alloy steel.

DA1209

13/16"

DA1210

5/8"



DA1219

Rear Main Seal Tool

Removes & installs upper rear main bearing seals without dropping the crankshaft. Steel fingers seal firmly, and piano wire & handle provides smooth flexible pulling for fast and easy change of bearing seals.



DA1220

Screw Extractor Set

Sharp undercut edges, gradual taper & long flutes providing a solid grip on broken studs, screws, pipe fittings. Made from heat treated chrome-moly steel. Sizes: 3/8", 5/16", 15/64", 3/16" & 1/8" (3, 5, 6, 8 & 9mm).



DA1230

Hand Punch Set

Punch holes in thin sheet steel, aluminium & brass. Powerful lightweight tool develops 1 tonne of punching force for piercing up to 14 gauge mild steel. Contains 3/32", 1/8", 5/32", 3/16", 7/32", 1/4" & 9/32" punches & dies, a die key & storage case.



DA1223

Screw Extractor Set

6 coarse threaded twist style extractors for easy removal of broken studs or screws. Made from heat treated chrome-moly steel. Sizes: 1/8", 1/4", 5/16", 7/16", 9/16" & 3/4".



DA1234

Pick & Hook Set

Stainless steel points with large comfortable handles. Set contains: awl, hook tool, 45° & 90° bent tools. Used for detailed works, scribing and picking jobs. OL 100mm



DA1225

29" Jumbo Pry Bar

Tang thru alloy steel square blade. Rugged plastic handle provides a firm grip.



DA1236

Scraper & Hook Set

Made of heat treated alloy steel. Suitable for gasket scraping, pins and clip picking. A multi-purpose 5pc tool kit.



DA1226

Nut Splitter

Used when access over the nut is NOT possible. Works on rusted or frozen nuts up to 15/16" (23mm).



DA1237

Pry Bar Set

Drop forged steel, heat threaded blades and visible high impact handles for comfortable grip & powerful leverage. Sizes OL: 8" (200mm), 12" (300mm), 18" (450mm) and 24" (600mm).



DA1227

Nut Splitter Set

Removes rusted or seized nuts easily without damaging the bolt thread. Use the 3-3/4" splitter on nuts from 1/8" to 5/8" & the 4-3/4" splitter, on nuts from 3/8" to 1" (3-8mm) & (5-25mm).



DA1238

Double Point Scriber

Knurled handle for firm grip. Stainless steel hook & pick points for removing O-rings, seals & grommets.

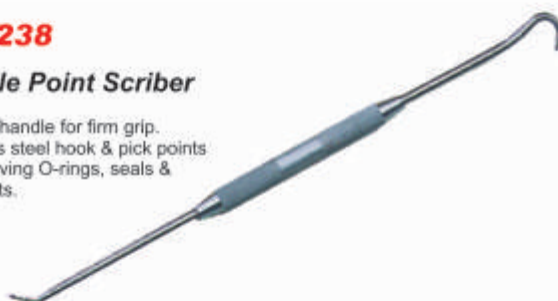

DA1228

Stud Puller Kit - SAE

Alloy heat treated steel sockets pull, or screw up screws without a head. Simply place socket on the screw, then turn to loosen or tighten. 1/2" Drive. Includes sizes 1/4", 5/16", 3/8", 7/16".



DA1240

Seal Puller Heavy Duty

For pulling any kind of packing on the basis of a double profile end. This also makes it easy to pull oil seals without damaging the supporting surface.



DA1241

Scraper Long Reach

280mm OL razor blade scraper. Includes 3 metal blades & 2 plastic blades.



DA1242

Gasket Scraper

Great for removing dirt & carbon from engine blocks.



DA1243

Razor Scraper

Pocket sized swings & locks in 3 positions. Also locks inside of handle for safe storage. OL Closed 110mm & open 190mm.



Super Razor Scrapers

Specially designed to reach into tight areas.

DA1245

8" (200mm)

DA1246

10" (250mm)



Razor Blades

Stainless steel single edged razor blades. Fits most standard razor blade tools.

DA1247

Pack of 10

DA1248

Pack of 100



DA1254

Trim Knife Blades, Pack of 10

Set of 10 heavy duty trim blades to fit most major trim blade tools.



DA1255

Engineers Scriber

Stainless steel 90 degree angle pick & straight points to scribe or pick O-rings & small parts.



DA1256

Multipurpose Scraping Knife

150mm blade features 3 sharp blade edges and 2 edge scrapers. Can be used as a cutting knife, awl, scraper, or stripping tool. Made from alloy steel and heat treated.



DA1259

Engineers Scriber

Stainless steel 45 degree angle pick & straight points to scribe or pick O-ring & small parts.



DA1263

Multi-Spline Extractor Set

Heat treated chrome-moly steel bits quickly & easily remove broken fasteners, screws, bolts, nuts, pipes & studs without breaking or jamming. Sizes: 1/8" to 13/32" by 1/32" (3-11mm).



DA1267

Stud Puller Kit - Metric

Alloy heat treated steel. Removes or tightens screws without a head. Simply place socket on screw, then turn it to tighten or loosen. Sizes Metric 6, 8, 10, 12mm.



DA1268

Gauge Set - Screw Pitch

SAE & Metric 2 gauges for gauging of American national standard threads. SAE: 12, 13, 14, 16, 18, 20, 24, 27, 28, 32, 36, 40 Metric: 0.5, 0.6, 0.7, 0.75, 0.8, 0.9, 1.0, 1.25, 1.5, 1.75, 27, 28. 12 blades in each tool.



DA1280

In-line Spark Tester

Checks HT system, fits all internal combustion engines. Set the tester between the spark plug & lead, start engine to obtain a quick and simple fault diagnosis.



DA1300

Feeler Gauge

Measures & adjusts spark plug gap from 0.02" to 0.1" (0.05-2.55mm). Flange edge for electrode bending.

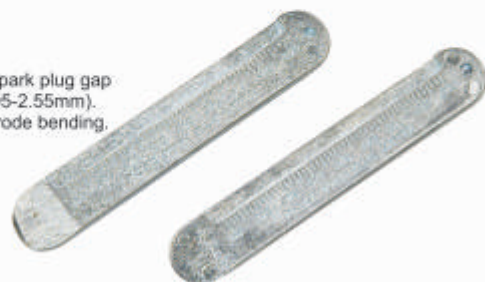

DA1291

High Tension System Testers

Pack of 4. Easy & quick check on high tension system. Just plug the testers into spark plugs then connect to high tension leads. Start engine, the neon tube will glow to indicate if signal is present. Not for use with deep seated spark plugs.



DA1306

Battery Carrier

Scissor lock type jaws with serrated teeth ensure a firm grip onto top and side terminal batteries up to 177mm. Strong leather handle helps lift and carry the battery.



DA1296

Battery Terminal Brush

Cleans corrosion and dirt from battery terminal posts and cable clamps. Internal and external wire brushes set into a metal case.



DA1307

Torx® E Socket Set

Torx® E sockets are specially designed to fit most fasteners found on engines & brake assemblies. Use with 1/2" drive tools or breaker bar. Sizes: E10, E11, E12, E14, E16, E18, E20, E22 & E24. Includes sturdy plastic case.



DA1297

Spark Plug Gauge & Gapper, Pack of 300

300 pieces packed into a jar for countertop sale. Tapered edge gauges or gaps all spark plugs from 0.02" to 0.1" (0.50-2.55mm). Flange designed hole can adjust side wire of plug without pressuring centre electrode.



DA1315

Torx® E Socket & Bit

Fits most special fasteners on vehicle assembly. Includes 7 E sockets E6, E7, E8, E10, E12, E14, E16, and 9 bits T10, 15, 20, 25, 30, 40, 45, 50, 55 plus one 3/8" drive hex bit holder.



DA1298

Spark Plug Gauge & Gapper

Tapered edge gauges or gaps all spark plugs from 0.02" to 0.1" (0.50-2.55mm). Flange designed hole can adjust side wire of plug without pressuring centre electrode.



DA1299

Battery Terminal Cleaner

Cleans corrosion and dirt from battery terminal posts and cable clamps. One end for clamp reaming, and one end is for positive posts.



DA1318

Torx® 24pce Tamperproof Bit Set

Made from chrome-moly steel & hardened. Includes 11 each of tamperproof Torx® bits in 30mm & 70mm lengths. T10, T15, T20, T25, T27, T30, T40, T45, T50, T55, T60. A 3/8" drive x 10mm hex bit holder, and a 1/2" drive x 10mm hex bit holder.

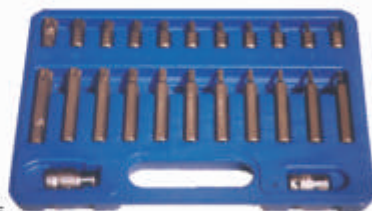

DA1319

40pce Mechanics Bit Set

S2 steel bit set. Contains: One of each bit holder in 3/8" and 1/2" drive x 10mm hex. 7 of 30mm & 75mm Torx® bits sizes T20, T25, T30, T40, T45, T50 & T55. 5 of 30mm & 75mm spline bits 5, 6, 8, 10 & 12mm. 7 of 30 & 75mm hex bits 4, 5, 6, 7, 8, 10, & 12mm



DA1320

Circuit Tester, Heavy Duty

Power on type tester for 6, 12, 24 Volt AC & DC. Durable 4" cellulose acetate handles. 121mm stainless steel probe with point cover. Heavy duty ground clip. 1500mm flexible cord.



DA1340

Spark Plug - Wire Tester

Locate faulty wires quickly, without piercing the wires. Light flashes when the lead is sound.



DA1322

Voltage Tester, High / Low

Two electrical testers in one, 48" OL ground wire. Low voltage tester checks 6, 12 volt systems for shorts, open circuits, grounds. High voltage tester checks plug wires, spark plugs and distributor checks.



DA1341

Spark Plug Terminal Plier

Insulated jaws & handles 200mm OL. Can also be used for light bulb removal.



DA1324

Continuity Tester

Battery powered tester checks all circuits with power off for shorts, grounds, contacts, diodes, fuses. 48" OL ground wire with ground clip. Uses one AA battery (sold separately).



DA1342

Spark Plug - Wire Plier

180mm OL, nylon tips and insulated handle protects against shock.



DA1329

Circuit Tester, Heavy Duty

Durable tester features 60" OL flexible ground wire with heavy duty clip. 4-3/4" sharp probe checks all 6, 12 & 24 volt circuits.



DA1343

Spark Plug - Boot Puller

L type, compact in size, for easy access to spark plugs. PVC dipped insulated handle protects against shock.



DA1332

Plug Hole Thread Chaser

10 x 14mm with 5/8" (16mm) hex. Tapered double ended design. Makes it easy to remove carbon, dirt or straighten damaged threads in spark plug holes. Use with a deep socket, open end or box wrench.



DA1344

Spark Plug - Lead Puller

Nylon tool, light weight. Stops the shock and beats engine heat. Pulls spark plug wires quickly.



DA1348

Extra Long Spark Plug Socket

3/8" drive 114mm OL for 5/8" (16mm) spark plugs. Extra long design allows easy access into recessed spark plugs. Knurled barrel for firm grip when hand turning. Rubber retainer holds plug securely and won't damage ceramic casing.



DA1380

Torx® Wrench Set

Made of hardened chrome vanadium steel. Includes sizes: E6x8, E7x11, E10x12, E14x18, E16x22, E20x24.



DA1408

Spark Plug Boot Plier - Heavy Duty

Long reach angle tips designed to remove hard to reach spark plug boots. Double insulated dipped to assure complete coverage of all contact areas. 230mm OL.



DA1369

42pcce Mechanics Bit Set

2 bit holders 3/8" & 1/2" drive plus 40 pieces of most popular sizes required or automotive service jobs. This set is useful to fit fasteners on cylinder & brake calliper. Chrome vanadium steel & heat treated. 7each 30 & 75mm star bits T20, T25, T30, T40, T45, T50 & T55. 1 each 30 & 70 mm star bits T60. 5 each 30 & 75mm spline bits 5, 6, 8, 10 & 12mm. 7 each 30 & 75mm hex bits 4, 5, 6, 7, 8, 10 & 12mm.



DA1418

Computer-Safe Circuit Tester

Operates from 3-15 volts. Supplied with 48" OL ground wire. Green colour LED indicates probe in + & clip in -. Red colour LED indicates probe in - & clip in +.



DA1420

Car Light Tester 6 to 24 Volt

Plastic casing body. Sharp probe tip covered with brass protection cap, check function of car lights fast and easily.



DA1370

Torx® Folding Key Set

Convenient folding type for easy & high torque application. Includes T9, T10, T15, T20, T27, T30 & T40. Made from chrome vanadium steel & heat treated.



DA1421

Spark Plug Firing Tester - Heavy Duty

Checks spark to measure ignition voltage without removing the spark plug. Works on conventional and electric ignition systems. Simply adjust calibration screw to proper gap size, put spark plug wire to the end of the tester, ground tester with clamp on engine, start engine to check spark.



DA1372

Torx® Tamperproof Key Set

Professional quality chrome vanadium steel. Tamperproof Torx® keys. Sizes: T10, T15, T20, T25, T27, T30, T40, T45 & T50.



DA1423

Battery / Alternator Tester

LED lights indicate car battery condition (engine stop) or output of alternator (engine running). Lights show poor, fair or good condition. Magnetic backboard keeps hands free for checking.



DA1425

Car Cord Tester

Does wire current check. Checks battery charge condition with 3 led lights. Checks high tension leads.



DA1434

Low Voltage Tester

Used to test automotive & marine fuse blocks, light sockets & trailer wiring. Clip ground first, then touch test probe to circuit being tested. Bulb glows when voltage is present.



DA1427

Circuit Tester 3 - 48 volts

Operates from 3-48 volts. Includes probe adapter for testing terminal connections. Supplied with 3 foot ground wire.



DA1435

Multi - Voltage Tester

Test 3, 6, 9 & 12 volts DC and 110 - 120 volts AC in automotive batteries, electrical systems, spark plugs and household batteries.



Long Range Circuit Tester

Use to check electrical circuit and accessories on all 6 & 12 volt systems in cars, trucks, boats, trailers, vans, recreation vehicles, motorcycles, airplanes and snow mobiles. Insulated extra long 165mm probe accesses hard to reach circuits.

DA1428

2.7 metre long retractable wire.



DA1429

3.65 metre long retractable wire.



Professional Circuit Tester

Use to check electrical circuit and accessories on all 6 & 12 volt systems in cars, trucks, boats, trailers, vans, recreation vehicles, motorcycles, airplanes and snow mobiles. Insulated 70mm probe.

DA1430

3.6 metre long retractable wire.



DA1431

2.7 metre long retractable wire.



DA1901

Lock Nut Socket - Truck Wheel Bearing

3/4" square drive x 2-3/32" (53mm) 6 point socket.



Circlip Pliers

Drop forged heat treated steel, easily removes and installs snap rings.



DA2861

Circlip Pliers 5" Internal - Straight Tip

DA2862

Circlip Pliers 5" Internal - 90° Angle Tip

DA2863

Circlip Pliers 5" External - Straight Tip

DA2864

Circlip Pliers 5" External - 90° Angle Tip

DA2865

Circlip Pliers 7" Internal - Straight Tip

DA2866

Circlip Pliers 7" Internal - 90° Angle Tip

DA2867

Circlip Pliers 7" External - Straight Tip

DA2868

Circlip Pliers 7" External - 90° Angle Tip

DA2869

Circlip Pliers 9" Internal - Straight Tip

DA2870

Circlip Pliers 9" Internal - 90° Angle Tip

DA2871

Circlip Pliers 9" External - Straight Tip

DA2872

Circlip Pliers 9" External - 90° Angle Tip

Quick Change Circlip Pliers

Thumb screw allows quick change to either internal or external pliers.

DA2884 Straight Tip

6" OL 10 - 25mm straight tip.

DA2885 Straight Tip

8" OL 18 - 48mm straight tip.

DA2886 90° Angle Tip

6" OL 10 - 25mm 90° angle tip.

DA2887 90° Angle Tip

6" OL 18 - 48mm 90° angle tip.



DA2895

Snap Ring Plier - External

Straight, 90 & 45 degree 3 tip positions converts easily with thumb nut. Comes with 3 sets of tapered tip nib sizes: 1.0 1.5 & 2.0mm diameter to cover most snap ring applications.



DA2985

Valve Stem Seal Plier

Long neck designed to reach into confined areas of the seal gripping it for removal. Serration on the tip grasps both original equipment & aftermarket seals regardless of their configuration.



DA2888

Quick Change Multi-Use Circlip Plier

One tool for either internal or external snap rings. Simply move the quick change reversing lever for internal or external alteration. Includes 4 sets of tips in a plastic box.



DA3002

Plier - Piston Ring

Tapered jaws hold and expands ring easily over piston. Adjustable stop prevents over-expanding and reduces ring breakage. Fits rings widths 3/64" to 1/4" (1.2mm-6.3mm) on most cars and light trucks.



DA2890

Lock Ring Plier - Angle Tip

Spread snap lock rings on brakes, transmissions, pedal shafts, clutch shafts & machine tools. Jaws have deep serrations on the outside of the tip to hold locking rings securely.



DA3006

Piston Ring Groove Cleaners

Sharp steel cutter removes carbon & tarnishes. Fits 2" to 5" (51-127mm) pistons. Three six-bladed cutters cover all major piston ring grooves SAE & Metric. SAE: 1/16", 5/64", 3/32", 1/8", 5/32", 3/16", 1/4". Metric 2.0, 2.5, 3.0, 4.0, 4.5mm Metric: 1.2, 1.5, 1.8, 2.8, 5.0, 5.5mm.



DA2891

Lock Ring Plier - Straight Tip

Spread snap lock rings on brakes, transmissions, pedal shafts, clutch shafts & machine tools. Jaws have deep serrations on the outside of the tip to hold locking rings securely.



DA3014

Valve Air Hold - Flexible

Allows for replacement of valve seals and broken or weak valve springs on OHV and OHC engines without removing the head by applying air to cylinder through spark plug hole. Flexible design allows for easy access to spark plug holes. One end fits 14mm and 18mm threads of spark plug hole, and the other end is a 1/4" NPT female for coupler plug attachment. 330mm long.



DA2894

Circlip Plier - 3 in 1 Internal

Straight, 90 & 45 degree 3 tip positions converts easily with thumb nut. Comes with 3 sets of tapered tip nib sizes: 1.0, 1.5, 2.0mm diameter to cover most snap ring applications.



DA3015

Valve Collet Replacer

Spring loaded unit places collets in position. The magnetic end can retrieve a dropped collet.



DA3018

Valve Lappers - 2 Pack

2pc set includes sizes 1-1/8" & 1-3/8" (28 & 35mm), and 5/8" & 13/16" (16 & 21mm) Cups. Hardwood handles for easy hand lapping valves. Two neoprene cups on one handle. Resistant to grease, gasoline and oil.



DA3019

Compressor - Wrinkle Band Ring

Compresses piston rings with less ring contact and lower friction. Band adjusts from 3" to 5" (76mm to 127mm).



DA3020

Compressor - Piston Ring

2" height, capacity: 1-1/2" to 3-1/8" (40-80mm).



DA3021

Compressor - Piston Ring

Self locking ratchet pawl prevents premature release and allows positive locking action. Friction-proof band edge makes a smooth & accurate operation. 3" height, capacity 2-1/8" to 5" (53-125mm).



DA3022

Compressor - Piston Ring

Self locking ratchet pawl prevents premature release and allows positive locking action. Friction-proof band edge makes a smooth & accurate operation. 3" height, capacity 3-1/2" to 7" (90-175mm).



DA3024

Compressor - Piston Ring

Self locking ratchet pawl prevents premature release and allows positive locking action. Friction-proof band edge makes a smooth & accurate operation. 4" height, capacity 2-1/8" to 7" (53-175mm).



DA3025

Compressor - Valve Spring

For small / medium OHV engines. Capacity 75-165mm, throat clearance 150mm. Universal model with strong adjustable cam-action, parallel lift and automatic locking.

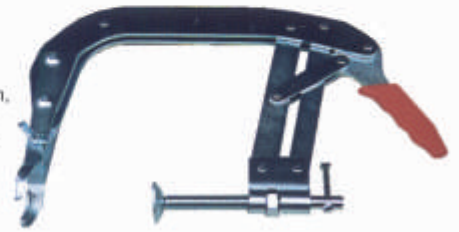

DA3026

Compressor - OHC Valve Spring

For overhead cam engines. Capacity 75-140mm, thread clearance 150mm. Universal model with fixed jaws, cam-action provides a parallel lift. Automatic locking leaves hands free to continue jobs. Intended for use on OHC engines and a wide range of OHV and CVH engines.

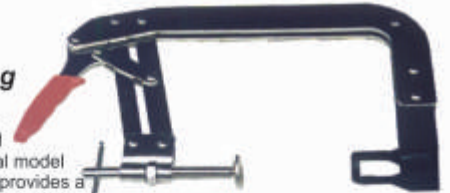

DA3027

Compressor - Valve Spring

For large engines, two sets of jaws included. Capacity 55-165mm for offset jaws. Capacity 75-185mm for straight jaws. Throat clearance 245mm. Heavy gauge steel construction works on the stiffest deep seated valve springs. Slim rugged jaws straight and offset allow maximum room to move or replace valve collets.



DA3032

Compressor Set - Piston Ring

Set includes 6 bands & plier, installs repetitive piston rings easily from 2-7/8" to 4-3/8" (73-111mm). Fine ratcheting plier permits an accurate compression and works both horizontally and vertically.



DA3036

Compressor Spring - Double Socket Valve

Reversible jaw adaptor for multi-valve engines. Capacity 45-145mm, throat clearance 250mm. Big window jaw adaptor for easy replacement of valve collets. Dual sizes in 25mm and 30mm dia. Unique direct action compressor lever gives improved visibility, and ease of use in areas of difficult access.



DA3037

Pliers - Automatic Piston

Spring action no adjustments needed to replace piston rings. Won't damage or distort rings when expanding all rings. For ring range 2" to 4" (50mm-100mm).

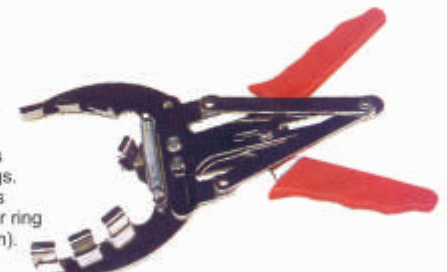

DA3038

Pliers - Automatic Piston Ring

Spring action no adjustments needed to replace piston rings. Won't damage or distort rings when expanding all rings. For ring range 3-1/8" to 4-3/4" (80mm-120mm).



DA3338

Pliers Flat Band Hose Clamp

Extra wide swivel jaws fit all style of flat band hose clamps. Ratcheting lock mechanism holds the clamp in an open position for easy setting.



DA3041

Compressor - Universal Valve Spring

Dual cam action provides choice of operation either above or below valve. Suitable for use on multi-valve petrol & diesel engines with deep seated valves. Also for use with OHC, OHV & CVH engines. Reversible jaws with 55mm - 175mm capacity. 165mm throat depth.

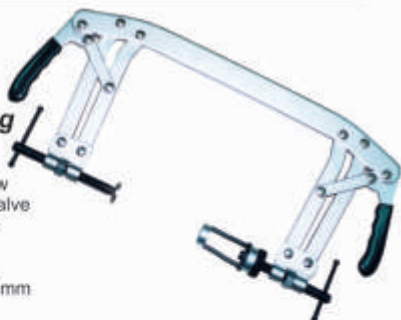

DA3342

Plier Narrow Jaw Hose Clamp

Special shaped swivel jaws that can adapt to many different kinds of hose clamp configurations. 360° swivel jaws.



DA3047

4pce E-Clip Tool Set

E-Clip sizes 6, 7, 8 & 9mm.



DA3344

Universal Hose Clamp Plier Set

Set includes cross slotted jaws plier & wide flat band hose clamp jaws plier to service most hose clamps in ring type or flat band type. Both pliers feature ratcheting lock mechanism holding the clamp in an open position for easy removal & installation.



DA3055

A/C Fuel Line Disconnect Tool Set

Includes sizes 1/4", 5/16", 3/8", 1/2", 5/8", 3/4" & 7/8".



DA3376

Fan Belt Hook Tool

Lightweight aluminium tool to assist adjusting of V-belts, serpentine and timing belts.



DA3057

A/C Fuel Line Disconnect Tool Set

Includes sizes 5/16", 3/8", 1/2", 5/8", 3/4" & 7/8".



DA3378

Nut Wrench Set - Thermo Viscous Fan

32mm & 36mm jaw opening for removal of thermo-viscous fans on Ford & BMW vehicles. Made from tempered pressed steel with PVC dipped handle.



DA3331

Hose Clamp Plier

Removes & installs spring wire hose clamps. Plier features ratcheting lock mechanism holding the clamp in an open position for easy removal & installation.



DA3379

Fan Clutch Wrench - Ford

Special clutch holder & nut wrench makes water pump replacement in Ford cars easy. 1-7/16" & 2-5/16" jaw opening.



DA3387

Fan Clutch Holder - Ford

Special designed slots fit over & grip firmly on three of the studs holding the viscous fan clutch assembly, to allow the release of the locking nut. Fits Ford Falcon, Fairlane and many vehicles.



DA3388

Fan Nut Wrench - 32mm

DA3389

Fan Nut Wrench - 36mm

Removes lock nuts on thermo-viscous fans found on Ford, BMW and many other vehicles. Made from tempered pressed steel with PVC dipped handle. 380mm OL



DA3392

Viscous 2pce Fan Nut Wrenches

Removes lock nuts on thermo-viscous fans found on Ford, BMW and many other vehicles. 380mm OL made from tempered pressed steel with PVC dipped handle. Wrench sizes 32mm & 36mm.



DA3396

Viscous 3pce Fan Assembly Tool

For viscous fan clutch removal & replacement. Two hub wrenches 32mm & 36mm opening & one special holding bar to fit fan clutch found on Ford and many other vehicles.



DA3400

Engine Lifting Chain

28" (710mm) long, 1/2 tonne SWL load capacity. Self balancing bolts-lock feature for safe, non-slip lifting.



DA3700

Hydraulic Valve Lifter / Puller

For the easy removal of stuck hydraulic valve lifters. Expanding collet & slide hammer does the job easily, even with those tightest lifters.



DA3707

Tyre Valve Installer

Heavy gauge steel bar handle for positive sealing of snap-in type valve systems. Notched shank accommodates various rim sizes.



DA3708

Tyre Valve Core Set

Durable bright handled core tools replace standard valve cores. Regular size for passenger cars, and the long size for use in trucks.



DA3710

Tyre Repair Tool Kit

Tyre plug kit for steel belted radial tyres. Easy to follow instructions included.

DA0030 Spare wicks for the DA3710 puncture plug kit. 30pcs of 7" long.



DA3711

4 in 1 Valve Stem Repair Tool

This high grade tempered steel tool sets the valve core, extracts the core, rethreads inside stem & outer part, and also can be used to install a new stem in tubeless tyre.



DA3712

Wheel Weight Plier

For removing & installing wheel weights and cutting stick on wheel weights. The drop forged heat treated tool is balanced and heavy enough to swing like a hammer.



DA3716

Master Wheel Wrench

21" extension handle gives extra leverage for stubborn fixings. Improved extension function that allows further extension by a clockwise turn of the handle, making the lug release more efficient. Supplied with 2 reversible sockets 17x19mm & 21x23mm.



DA3770

Mini Tube Cutter

Hardened alloy steel cutting wheel cuts 1/8" to 5/8" (3 - 15mm) O.D. range.

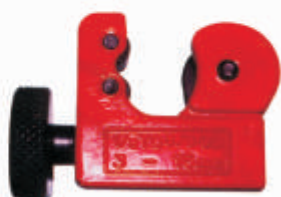

DA3805

Quick Disconnect Coupler Tool - Ford / GM

For use on GM transmission oil cooler to radiator lines. Also Ford fuel lines with hairpin connectors.



DA3774

3 in 1 Precision Tube Bender

Durable metal construction with gauge. Accurately bends 1/4", 5/16" or 3/8" O.D. tubing with precise bend angle.



DA3807

Welsh / Freeze Plug Puller

Pulls freeze plugs up to 2" diameter. To pull, drill 17/64" diameter hole first.



DA3775

Tube Cutter

Hardened cutting wheel cuts copper, brass, aluminium or mild steel tubing 1/8" to 1-1/8" (3 - 30mm) O.D. Tapered burr remover, cleans burrs after cut.



DA3811

Fuel Line Quick Disconnect Tool

Releases 5/16" & 3/8" fuel line locking on GM, Ford, Chrysler and Mazda vehicles.



DA3779

Flaring Tool Set

Professional universal flaring tool for fuel and brake lines. Works in two steps for thin walled steel, aluminium or copper pipes. For 3/16" (4.75mm) and 1/4" (6mm). Fast operation and minimal material wastage.

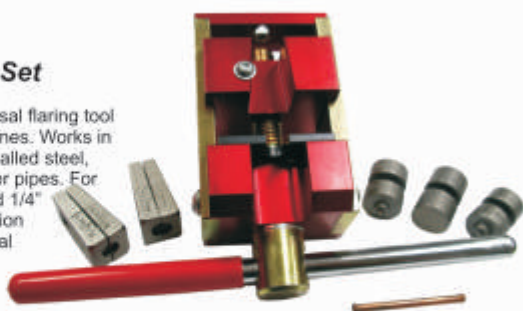

DA3812

A/C & Fuel Line Spring Lock Coupling Tool

Scissor type, creates 4 sizes of 3/8", 1/2", 5/8" & 3/4" for most Ford & Chrysler vehicles equipped with spring lock couplings on A/C & fuel lines.



DA3791

Radiator Fin Tool

6-in-1 straightener cleans & straightens condenser & evaporator coil fins having spaces of 8, 9, 10, 12, 14 & 15 fins per inch. Small, compact firm screwdriver handle easy to use in confined spaces.



DA3814

A/C & Fuel Disconnect Tool Set

Tools service most kinds of quick-disconnect fittings used on Ford, GM & Chrysler vehicles. Contains: Ford / Chrysler / GM fuel line disconnect tool, Ford fuel line coupling tool, Ford / GM quick-disconnect coupler tool, A/C & fuel line spring lock coupling tool.



DA3799

Ball Joint Separator

Heat treated drop forged steel body & bolt for long rough usage. Spread ball joints easily where space prevents use of a direct action method. Jaw opening 19mm, maximum opening 38mm.



DA3860

Bearing Cup Remover

Hardened drop forged alloy steel jaws for pulling internal bearing caps, seals, bushings. A cone holds the jaws in place during pulling. Jaws spread 5/16" to 3-1/4", reach to 3-1/2". Use with 5/8"-18 slide hammer.



DA3861

Pilot Bearing Puller

Forged alloy steel jaws can be opened by a tapered cone to hook onto the bearings from 1/2" to 1-1/2" (12 - 38mm) I.D. found on flywheels, water pumps driving shaft and many other parts.



DA3862

Puller - Inner CV Joint

With this tool the axle assembly is popped out of the transaxle without damage to transmission case or inside roller bearing.



DA3863

Puller Set - Rear Axle Bearing

These pullers quickly remove semi-floating rear axle bearings. Use with 5/8"-18 side hammer. 3 pullers fit min. 1" I.D. of bearing tube, max. 1-7/8" I.D. of axle tube. Min. 1-5/16" I.D. of bearing tube, max 2-3/8" I.D. of axle tube. Min. 1-3/8" I.D. of bearing tube, max. 2-7/8" I.D. of axle tube.



DA3865

Slide Hammer - 10lb

26" long, 10 lb. hammer to fit any puller adapters threaded 5/8"-18. Heavy duty hammer pulls stubborn hubs or flange-type axles easily.



DA3866

Slide Hammer - 5lb

24" long with 5 lb. Hammer & 5/8"-18 threaded end. Hardened shaft with chrome plating.



DA3871

Puller Plate - Rear Axle

Pulls flange-type rear axles on most late model passenger cars & light trucks. Designed to fit axles with bolts & studs up to 9/16" dia. 4, 5, or 6 - bolt stud circle from 4-1/4" to 5-9/16".



DA3874

25pce Hydraulic Puller Set

A heavy duty master set of gear puller & bearing splitters, 10 tonne hydraulic ram plus forged puller arms & bearing splitter make replacement of gears, bearing, harmonic balancers & other tightly fitted parts easy. Ideal for servicing passenger cars, light/heavy duty trucks, off-road construction equipment and machinery.



DA3874IRK

Seal Kit - Hydraulic

Seal kit for DA3874



DA3897

Puller Set - 9 Way Slide Hammer

A master tool set for an auto body shop. 9 different purpose slide hammer attachments, to handle most body dent repairing jobs. 10 lb. slide hammer assembly for those rugged jobs.



DA3948

Universal Ball Joint Separator

Suits most cars and light trucks ball joints in steering & suspension. Offset lever permits maximum jaw openings in 30mm (1-3/16") & 56mm (2-3/16"). Jaw open 22mm.



DA3952

8pce Special Socket Set

Special sockets for antenna nuts, radio trim nuts, remote control mirror adjustment lever and ball joint sleeve. The set services Ford, VW, GM, Nissan, GMC, Mitsubishi, Chrysler, Mazda & Toyota vehicles.



DA3953

5pce Antenna Socket Set

5pce set has sockets to fit most antenna nuts found on GM, Ford, Chrysler, VW, Nissan, Mitsubishi, Toyota & Mazda vehicles.



DA3957

Double Flaring Tool Kit

For double or single flares on copper, brass, soft steel or aluminium tubing with sizes: 4.75, 5, 6, 8, 10mm, 1/4" & 1/2" O.D.

DA3957-4-75

Spare 4.75mm former for DA3957.



DA3978

Brake Rivet Tool Kit

Punch off worn brake lining, and rivet new lining on drum brake.



DA3958

Double Flaring Tool Kit - Imperial

For double or single flares on copper, brass, soft steel or aluminium tubing with sizes: 3/16", 1/4", 5/16", 3/8", 7/16", 1/2" & 5/8" O.D.



Bearing Separators

Tools made from drop forged alloy steel, hardened and chrome plated. Each tool features sharp edges for easy placement behind the part. Providing a secure surface even when clearances are limited.



3 Jaw Gear Pullers

DA3959

75mm CR-V

DA3960

100mm CR-V

DA3961

150mm CR-V



DA3996

30 - 50mm

DA3997

50 - 75mm

DA3998

75 - 105mm

DA3999

105 - 150mm

DA4000

Steering Wheel Puller Kit

Pulls most steering wheels. Also used for removing pulleys, small engine flywheels, flanges and gears with tapped holes. 3" cap bolts with 2 of each 3/8" x 16, 5/16" x 18 & 5/16" x 24.



2 Jaw Gear Pullers

DA3962

75mm CR-V

DA3963

100mm CR-V

DA3964

150mm CR-V

DA3965

200mm CR-V

DA3966

300mm CR-V



DA4001

Multi-Purpose Puller Set

Multi-purpose puller set for balancer, pulley, gear & flywheel. Drop forged 4-slot yoke and a variety of cap bolts and forcing screw tips make this set universal.

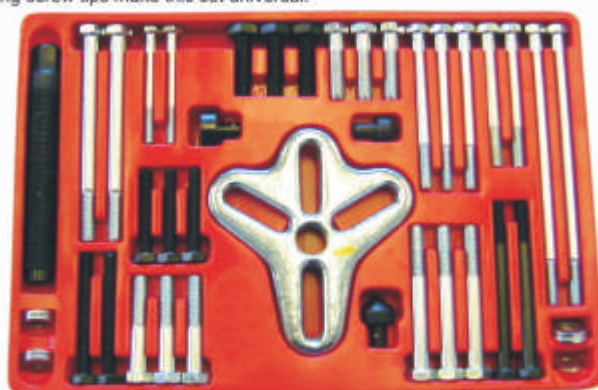

DA4004

6 Way Slide Hammer & Puller Set

This tool kit can pull flange-type rear axles, remove stubborn oil seals & bearings or press-fit parts. Use as a dent puller or lip puller, reversible jaws can be set up for 2/3 jaw in-external usage, 1/2"-20 thread adaptor expands the slide hammer for extra pulling functions.

DA4004/L 3pce spare legs for DA4004



DA4022

Coil Spring Compressor Set

A speciality tool for use on all vehicles equipped with Macpherson struts. Rapidly compress the coil spring for replacement of shock absorbers, spring sets, the repair of bent struts and damaged spindles. Durable jaws with safety hooks.

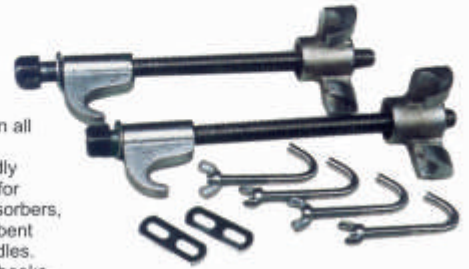

DA4005

Professional Gear Puller Set

The puller set is ideal for wide range of pulling jobs, gear sizes from 9/32" to 3" (7mm - 75 mm). Permits damage-free pulling of gears, bearings, harmonic balancers and other parts. Tools made from drop forged steel, heat treated & black finished.

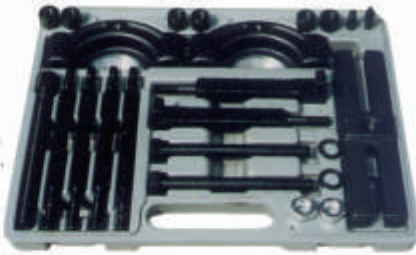

DA4024

Coil Spring Compressor Set

Drop forged carbon steel jaws and lead screws, both heat treated ensure you obtain professional job performance. The tool is designed for use in limited space under wheel arch. Jaw design is fitting to wrap coil claws for safety. Maximum jaw opening is 230mm.



DA4008

Pitman Arm Puller

Heat treated drop forged yoke & heavy duty centre screw for easy removal of pitman arms. 1-5/16" (33mm) opening with 2-1/2" (60mm) depth.



DA4025

Coil Spring Compressor Set

Tempered chrome-moly steel jaws with ACME threaded lead screw. Quickly & safely compress coil springs on all passenger cars & pick up trucks, 300mm rod and jaw opening ranges 210mm to 360mm.



DA4009

Valve Spring Clamp

Long offset jaws for high performance engines, this tool removes valve springs on most OHV engines without removing the head.



DA4031

Tie Rod / Ball Joint Remover Kit

Heat treated drop forged alloy steel forks in sizes of 11/16" (18mm), 15/16" (24mm) & 1-1/8" (29mm) and two handles, one for hammering, the other for use with air hammer (.0401"). All forks are threaded to interchange with handle for separating tie rods, ball joints, pitman arms and other uses.



DA4011

Universal Tie Rod End Tool

Heat treated drop forged steel body & thrust bolt. Fits most cars, simply insert tool between spindle arm and tie rod, turn thrust bolt with 3/4" (19mm) socket or spanner to spread tie rod easily. Fork 18mm (11/16").



DA4034

Ball Joint Separator

Tempered drop forged steel one piece construction for long & rough usage. 21/32" (18mm) fork, 16" (410mm) length replaces worn out tie rods easily with a hammer striking. Can also separate shock absorber links.



DA4035

Tie Rod Separator

Tempered drop forged steel one piece construction for long and rough usage. 15/16" (24mm) fork, 11-7/8" (300mm) length replaces worn out ball joints easily with a hammer striking. Also can remove CV drive shafts on 4WD vehicles.

DA4020

Coil Spring Compressor Set

Tempered carbon steel lead screws (230mm) with economic ductile casing jaws that wrap over coil claws for extra safety. Suitable for use in limited space underneath wheel arch. Use with 1/2" drive wrench. 230mm max jaw opening.



DA4059

Timing Gear Puller

Specially Designed versatile puller for timing gear removal. Pulling by center forcing screw permits a damage-free service. Also removes fan pulleys & other parts with tapped holes. 4-3/4" (120mm) cross block, slot opening 10mm.



DA4083

Ball Joint Separator

Opening 17mm, length 200mm. Removes ball joints from vehicles. Insert between ball joint & main body, hammer the tool to loosen or remove tie rod.



DA4088

Ball Joint Service Kit

This heavy duty tool kit is excellent for the removal & installation of press-fit parts such as ball joints, universal joints & truck brake anchor pins. This can now be accomplished without resorting to makeshift methods. It will even remove rusted & corroded parts. Set contains a C-Frame press, 3 receiver tubes 2-3/4"x3", 2-1/4"x2-1/2" & 1-3/4"x2" and installation & removing adapters.



DA4089

Master Ball Joint Service Kit

With 3 more tubes & cups to expand the capability of DA4088 set for removal & installation of upper & lower ball joints on Dana 44 front axles found on most 1967-current 1/2 & 3/4 tonne 4WD Ford, GM, Dodge, IHC & Jeep vehicles.



DA4090

Universal Tie Rod Tool

Double-end design turns split tie rod sleeves 360 degrees in confined spaces. A must have tool for wheel alignment.



DA4096

Universal Hub Separator

Complete versatile adaptors included to handle hub removing from most popular front wheel drive vehicles. Acme threaded forcing & adjusting screws make rugged jobs easy & efficient. Applications: GM, Ford, Honda, Mazda, Toyota, Nissan, Mitsubishi, Daihatsu, Subaru, Suzuki, Saab, VW, Fiat, Renault & Hyundai.



DA4098

Hydraulic Bearing Puller Kit

10 tonne hydraulic power & sharp edged splitter. Handles removal of most tightly fitted parts or when there isn't a good gripping surface on part to be pulled. Bearing splitter capacity 75-105mm, 2 each 8" main rods and extension rods for long reach operation.



DA4107

Vacuum Switch Socket

3/8" drive 7/8" flare nut socket for vacuum switch & oxygen sensor service on computer controlled engines.



DA4118

Rear Axle Flange Nut Socket

The special socket removes rear axle flange grooved nuts, on Mercedes Benz models 107, 114, 115, 116, 126 axle with CV joints, when replacing axle seals and axle bearings.



DA4120

Oxygen Sensor Socket

3/8" Dr. 7/8" x 90mm long, 20mm slot for vacuum PVS TVS valve & oxygen sensor on Ford, GM, Chrysler & other cars.



DA4124

Vacuum Switch Socket

3/8" drive 7/8" x 80mm long, 7mm slot for oxygen on computer engine controlled cars.



DA4135

4WD Axle Nut Impact Socket 36mm

Alloy steel, heat treated, black finished, 1/2" drive x 36mm hexagon, 2" (50mm) OL.



Oil Pressure Switch Tool

DA4136

For quick removal and replacement of oil pressure sending units. Two-step design fits 1" & 1-1/16" oil pressure sending units. Use 3/8" square drive or 3/4" hex tool.



DA4139

For quick removal and replacement of oil pressure sending units. Similar to DA4136 but without 3/4" hex on the stud. Two-step design fits 1" & 1-1/16" oil switch.



DA4140

Oil Pressure Socket

1/2" Dr. 1-3/16" x 3-1/2" long. For oil pressure sending unit on 2.0, 2.3, 2.5, 2.8, 3.0L GM's cars.



DA4151

Gland Nut Wrench

Adjustable jaws to fit hydraulic cylinders on vehicles having gland nuts from 1" to 3-3/4" dia. It's reversible to fit 1/4" and 7/32" pin holes. Use with 1/2" drive tool to loosen toughest nuts.



DA4545

Carburettor Main Jet Tool Kit

For Holden 6 Cyl 1964-79, Holden 8 Cyl 1969-79, Ford 6 Cyl 1966-80 & Ford 8 Cyl 1970-73.



DA4546

Rochester 4 Barrel Carburettor Service Kit

For most Holden 8 Cyl 1969 and on. The kit allows adjustments, removal & installation of previously fixed turning components on this popular carburettor.



DA4547

Rochester Varajet Mikuni Solex Idle Screw Adjuster

Mitsubishi Magna 1985 and on, Camira 1982 and on, Kingswood WB 1980 and on, Commodore 1980 and on. The tool permits fast, easy adjustment of recessed idle mixture & speed screws.



DA4548

Carburettor Adjusting Tool

For idle / mixture screws on GM & Chrysler. Heavy-duty flexible shaft for easy access. 4 adapters stored in the hollow handle, includes: Double D for GM 1979-up. 1/4" hex for GM 1978-up. 3/32" hex for Chrysler 1978-up. 4.5mm hex for 1978 & 1979 GM.



DA4559

Fuel System Service Kit

Comprehensive kit contains tools that fit most vehicles.



DA4562

Offset Distributor Clamp Wrench

Reaches around obstructions to turn the distributor lock nut with its double-ended wrench 1/2" & 9/16". Use tool by itself, or with 3/8" square drive tools.



Stud Remover & Setter Kits

The best way to remove studs without causing damage to the shanks. The tapered collets thread on to stud, even if only a few threads are exposed, tightening the housing bolt draws the collet into the tapered housing & securely clamps the collet onto the stud.



DA4572 SAE Stud Remover & Setter Kit

Comes with housing and 14 collet pieces in SAE: 1/4-20, 1/4-28, 5/16-18, 5/16-24, 3/8-16, 3/8-24, 7/16-14, 7/16-20, 1/2-13, 1/2-20, 9/16-12, 9/16-18, 5/8-11 & 5/8-18.

DA4573 Metric Stud Remover & Setter Kit

Comes with housing and 14 collet pieces in Metric 6x1, 7x1, 8x1, 8x1.25, 9x1, 9x1.25, 10x1.25, 10x1.5, 12x1.25, 12x1.5, 14x1.5, 14x2, 16x1.5 & 16x2.

Dowel Pin Puller Sets

Removes press fitted dowel pins from engines, crankshafts and other surfaces. 3 pound slide hammer removes toughest dowel pins.

DA4575
7 collets: 1/4, 5/16, 3/8, 7/16, 1/2, 9/16, 5/8" & a housing.

DA4576
7 collets: 6, 8, 10, 12, 14, 16mm & a housing.



DA5520

Disc Brake Piston Tool

For rotating the piston back into the calliper. Fits, Ford Laser, Mitsubishi, Hyundai, Proton, Telstar & Mazda 323, 626.



DA5527

Bendix Brake Spring Tool

For Bendix brakes that have a return spring hooking over a post. The socket end removes spring, by rotating the hook off post. The opposite end leverages spring onto post.



DA5554

Brake Spring Compressor

Big window design for good visibility during operation. Allows fast & easy removal & replacement of brake shoe hold-down springs.



DA5530

Brake Spring Pliers

Special heavy duty design for easy removal & installation of shoe return springs on most drum brakes. 13" (330mm) OL.



DA5555

Disc Brake Pad Spreader

Round handle type. Makes changing pads easy. Compresses disc brake pistons when installing pads on most cars & trucks.



DA5531

Brake Adjusting Tool

Fits all brakes other than Chevrolet. One end square cut, the other tapered for added reach. 9" (225mm) OL.



DA5557

Disc Brake Pad Spreader

T-handle type. Makes changing pads easy. Pushes brake pistons to install pads on most cars & trucks.



DA5533

Brake Spoon

Short length for vehicles with limited access. 4-7/8" (124mm) OL.



DA5559

Disc Brake Piston Spreader

Fits in brake calliper to push back pistons for new brake pad installation.



DA5535

Brake Shoe Spring Tool

A tool for lockhead & total contact brakes.



DA5561

Brake Return Spring Tool

Hook the brake return spring and screw up to lock it for removal & installation. A smart tool to service those brakes that don't use anchor pins.



DA5553

Brake Spring Compressor

To remove & replace brake shoe hold-down springs. Bevelled cup fits most sizes. Knurled design for firm gripping of springs.



DA5564

Brake Spring Washer Tool

Fits both large & small washers. Removes & installs brake shoe retaining spring washers easily with a wide window for better visibility to align the washer slot & nail.



DA5570

One Man Brake Bleeder Kit

Simple to use brake bleeder with no mess. Set includes hand-free strong magnet fluid collection bottle & hoses with tapered fittings.



DA5574

One Man Brake Bleeder Hose

One-way check valve built into hose. Allows user to control flow of fluid.



DA5580

Vacuum Pump / Brake Bleeding Kit

A complete kit for vacuum testing and one man brake bleeding. Contains vacuum pump, brake bleeding kit, hose & adaptors in a plastic case.



DA5589

Rear Disc Brake Piston Cube

Use with 3/8" drive ratchet for rotating piston into the calliper when replacing brake pads. Fits most cars.



DA5593

Universal Brake Calliper Wind-Back Tool Kit

Winds back brake piston for replacing brake pads. Fits most cars including BMW, Ford, Honda, Mazda, Mercedes, Mitsubishi, Nissan, Toyota, VW & Audi. Also includes adaptor for GM vehicles.

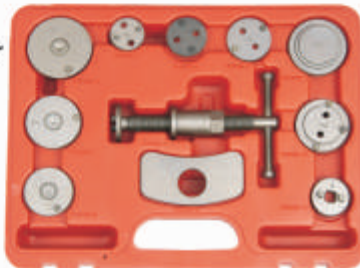

DA5800

3 Leg Engine Cylinder Hone

Fits cylinders 2" to 7" (50-135mm). 3 medium grit stones 4" (100mm) long for quick polishing or honing. Flexible driver gives good stability without cutting.



DA5802

3 Leg Brake Cylinder Hone

Fits cylinders 1/4" to 3-1/2" (32-92mm). 3 medium grit stones 2" (50mm) long. Square ended stones polish to the end in step-cut or blind-end cylinders. Flexible shaft with adjustable pressure polishes without cutting.



DA5803

3 Leg Brake Cylinder Hone

Fits cylinders 3/4" to 2-1/2" (19-64mm). 3 medium grit stones 1-1/8" (28mm) long. Flexible shaft for good finish.



DA5805

3 Leg Brake Cylinder Hone

Fits cylinders 3/4" to 2" (19-50mm). 3 medium grit stones 1-1/8" (28mm) long.



DA5806

2 Leg Brake Cylinder Hone

Fits cylinders 1/2" to 2-1/2" (13-64mm). 2 medium grit stones 1-1/8" (28mm) long. Adjustable pressure for speed honings.



DA6000

10 in 1 Trim Tool

The panel beaters best friend. Performs ten jobs from door trim removal to windscreen clip removal & everything in between. This tempered steel tool has a vinyl coated handle for comfort and ease of use.



DA6101

Small Tail Pipe Expander

Internal design operates with simple wrench. Standard equipment for all tail pipe expanding. Work range: 1-1/8" to 1-3/4" (29-44mm).



Tail Pipe Expanders

Internal design operates with simple wrench.
Standard equipment for all tail pipe expanding.

DA6103

Medium Tail Pipe Expander

Work range: 1-1/2" to 2-1/2" (38-64mm).

DA6105

Large Tail Pipe Expander

Work range: 2-3/8" to 3-1/2" (54-89mm).



DA6656

Universal 3 Leg Oil Filter Wrench

Fits most popular oil filters on passenger cars and light trucks. Made from carbon steel and heat treated. For ranges: 2-1/2" to 3-7/8" (63-99mm).



DA6642

Motorcycle Oil Filter Wrench

Special tapered legs for small oil filters sizes 45-75mm. Use 3/8" square drive or 3/4" hex drive tools.



DA6663

2pce Male Drain Plug Wrench Set

8 different sizes in one tool for the removal of drain plugs. SAE: 3/4, 5/8, 9/16, 1/2, 7/16, 3/8, 9/16, 1/4-7/16, 1/8-1/4". Metric: 10, 11, 12, 13, 14, 15, 17mm



DA6649

6pce Dual End Drain Plug Key Set

Double ended alloy steel keys for easy removal of sump plugs, gear box & back axle drain plugs. Use with 14mm hex drive tool. 6 pieces in 12 sizes: 8mm x 10mm hex, 17mm x 1/2" hex, 5/16" x 3/8" hex, 8mm x 3/8" square, 11mm square x 12mm hex, 13mm square x 14mm hex.



DA6673

Oil Filter Plier

Hardened drop-forged CR-V steel tool removes stubborn filters. Slip joint design makes adjustment fast and easy. 9" plier for 2-3/8" to 3-1/2" (60-90mm) filters.

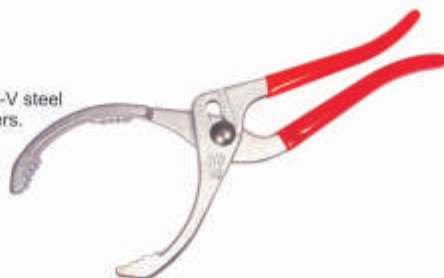

DA6650

3 Leg Oil Filter Wrench

Loosens or tightens oil filters from 65-120mm diameter. Use with 3/8" square drive or 3/4" hex drive tools.



DA6674

Traditional Oil Filter Wrench

Traditional handle for use where filter access is less critical. For 2-7/8" to 3-1/8" (73-80mm) filters.



DA6652

3 Leg Oil Filter Wrench

Fits oil filters in sizes 63-120mm diameter. Use with 1/2" or 3/8" square drive or 13/16" hex drive tools.



DA6675

Oil Filter Plier

Hardened drop-forged CR-V steel tool removes stubborn filters. Slip joint design makes adjustment fast and easy. 10" plier for 3-3/8" to 4-1/2" (85-115mm) filters.

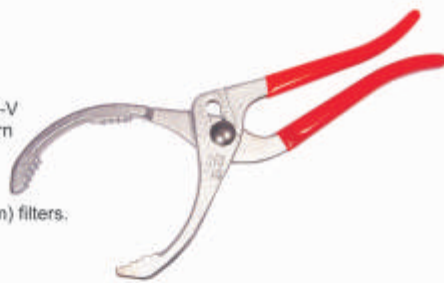

DA6654

3 Leg Oil Filter Wrench

Fits oil filters in sizes 63-102mm diameter. Use with 1/2" or 3/8" square drive or 13/16" hex drive tools.



DA6676

Traditional Oil Filter Wrench

Traditional handle for use where filter access is less critical. For 3-5/8" to 3-15/16" (92-100mm) filters.



DA6677

Clincher-Type Oil Filter Wrench

Features multiple rows of teeth for super gripping action. For 2-3/4" to 3-3/4" (70-95mm) filters.



Ratchet Oil Filter Wrench

DA6678

For use with 3/8" square drive tools. Made of tempered spring steel. For 2-13/16" to 3-1/4" (71-82mm) filters.



DA6680

For use with 3/8" square drive tools. Made of tempered spring steel. For 3-5/8" to 3-15/16" (92-100mm) filters.

DA6681

Adjustable Oil Filter Wrench

3-step link allows tremendous range in one tool. For 2-3/4" to 4-1/4" (70-108mm) filters.



DA6682

Deluxe Oil Filter Wrench

Tempered spring steel band with gripping studs securely holds the filters for easy removal. For 3" to 3-3/4" (75-95mm) filters.



DA6683

Micro Adjustable Filter Wrench

Micro adjusting screw for super gripping to oil or fuel filters. Heavy-duty construction. For 2-1/4" to 4" (57-100mm) filters.



Cam-Type Oil Filter Wrench

DA6684

Heavy-duty cam-type oil filter wrench for use with 1/2" square drive or 1" hex drive tools. For 2-3/4" to 3" (70-75mm) filters.



DA6685

Heavy-duty cam-type oil filter wrench for use with 1/2" square drive or 1" hex drive tools. For 3-3/8" to 3-7/8" (86-98mm) filters.

DA6686

Nylon Strap Oil Filter Wrench

Sturdy non-slip nylon strap handles spin-type filters up to 6" (150mm) diameter. For use with 1/2" square drive tools.



DA6688

Chain Oil Filter Wrench

16" chain wrench with vinyl-dipped steel handle for applications up to 4" (100mm) diameter.



DA6689

Heavy Duty Chain Filter Wrench

Durable ductile casing handle with sharp teeth provides a secure grip & leverage to remove the toughest filters. 13" chain for max 3-1/2" (89mm) filters.



DA6690

Heavy Duty Chain Filter Wrench

Vinyl-dipped heavy gauge steel handle. 16" chain easily removes most filters up to 4" (100mm) diameter.



DA6691

Socket Drive Chain Filter Wrench

Compact 1/2" drive socket with 16" chain. Suits filters in confined areas. For max 4-1/4" (108mm) filters.



DA6692

Band-Type Oil Filter Wrench

Spring steel strap with durable body & control knob tighten filter by adjusting screw for damage-free removal. Ideal for newer vehicles. For 2-1/2" to 4-3/8" (65-110mm) filters.



DA6693

Heavy Duty Oil Filter Wrench

Durable body with spring control grip jaw removes filters fast. For 2-1/2" to 3-7/8" (63-98mm) filters.



DA6700

Oil Filter Plier

Heat treated CR-V steel jaws & carbon steel handle, triple chrome plated. Fits most vehicles, from small cars to trucks. Jaw opening 2-1/8" to 4-5/8" (53-118mm) filters. Also suitable for water filters.



DA6694

Strap-Type Oil Filter Wrench

16" reinforced, rubberised non-stretch strap removes wide range of filters from 2" to 4-1/4" (50-112mm).



Super-Grip Adjustable Oil Filter Wrench

Non-slip band designed for strong grip. Swivel handle for tight areas. Notched link allows setting to one of four places.



DA6703

For 2-1/2" to 3-1/2" (60-89mm) filters.

DA6704

For 3" to 4" (75-100mm) filters.

DA6695

Deluxe Chain - Type Filter Wrench

Comfortable handle grip makes filter replacement fast & easy. 16" chain for max 4" (100mm) dia filters.



DA6705

Dual Drive Oil Filter Wrench

3/8" & 1/2" dual square drive body with extra wide cordura strap permits high torque. Can also be used with 13/16" (21mm) hex tools. For max 12" (300mm) filters.



DA6696

Chain Oil Filter Wrench

Light weight, rust proof cast handle. 16" chain removes max 4" (100mm) dia filters.



DA6707

Heavy Duty Chain Filter Wrench

Durable ductile casing handle with sharp teeth provides a secure grip & leverage to remove the toughest filters. 16" chain for max 4" (100mm) filters.



Economic Oil Filter Wrench

DA6697

Specially designed for easy removal of canister-type filters. For 2-7/8" to 3-1/4" (73-83mm) dia filters.

DA6698

Specially designed for easy removal of canister-type filters. For 3-1/2" to 3-7/8" (89-98mm) dia filters.



DA6708

Band-Type Oil Filter Wrench

Spring steel strap with durable body & control knob tighten filter by adjusting screw for damage-free removal. Ideal for newer vehicles. For 3" to 6-1/8" (75-155mm) filters.



DA6699

Heavy Duty Socket Drive Chain Filter Wrench

Heavy-duty chain & socket removes the toughest filters. For use with 1/2" square drive tools. For max 4-1/4" (108mm) filters.



DA6731

Heavy Duty Oil Filter Wrench

For 2-7/8" to 3-3/8" (73-85mm) filters.



DA6733

Heavy Duty Oil Filter Wrench

For 3-3/4" to 4-4/8" (95-111mm) filters.



DA6788

Double Action Vacuum Lifter

Sturdy plastic construction with 2 suction pads and individual lever operated. Ideal for heavy lifting applications.



DA6803

Universal Lockout Tool

This kit is produced for the purpose of opening almost any vehicle.

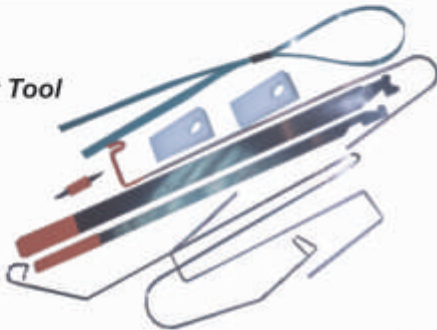

DA6806

Vacuum Suction Cup

6" cup pulls out panel dents safely and easily. Can also be used for many other jobs including holding windshields for installation & lifting metal or plastic. Swivel steel bar permits pull with chain & jack. No trigger or gum to break off, simply lift the lipped edge to release vacuum.



DA6810

4pc Filler Application Set

Made from spring steel with plastic handles. 4 piece set of 1", 2", 3" & 4".

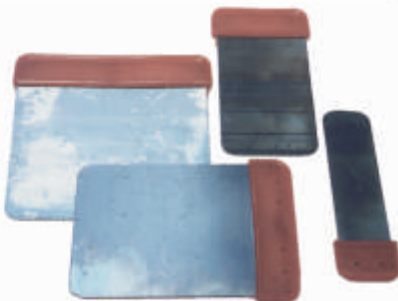

DA6821

Sanding Block with Wooden Handle

Lightweight aluminium body & wooden handle plus sponge pad makes sanding easy & efficient. 71x 230mm block size.



DA6822

Sanding Block - Plastic

Durable, lightweight ABS plastic. Features spring control sand paper loading clips for easy and fast performance. 106 x 212mm block size.



DA6826

Band-Type CV Boot Clamp Tool

Works on all CV joints with band-type boot clamps. This tool provides easy, fast & proper installation of those clamps.



DA6827

Ear-Type CV Boot Clamp Plier

This tool is specially designed for ear-type clamps fitted to late model GM CV joint boots. Also installs Perma quick-type clamps used on filters, cooling systems and vacuum lines.



DA6834

Door Upholstery Clip Remover

This well designed tool removes upholstery clips in just a few seconds. Simply place the tool under edge of door panel & insert into fastener, then pry up.



DA6846

Weather Stripping Tool

With this tool you can lift rubber weather stripping up and away from metal surfaces around the window and insert polypropylene string for temporary masking to the slots while doing metal surface treatment. The tool is double ended with taper and string guider for weather-stripping lift and inserting of the string. 2 sizes of string in 2mm & 4mm diameters for proper masking application to different slots.



DA6847

2 in 1 Auto Clip Remover

Easily removes door handles and clips, 2 different sized slots on each end that fit most body trim clips.



DA6850

Windshield Remover

Comfortable grip large durable aluminium handle plus sharp edge cutting blade. With the help of a steel cable pull handle, this tool removes windshields quickly and easily. The tempered steel blade can be resharpened or replaced with a new one.



Spare blades - DA6883

DA6851

Wire-Type Windshield Remover

Aluminium handles & tempered steel wire form a cutting sealant around gasketless windshields. This tool is able to resist strong tugging for tough pulling jobs.



DA6852

3 in 1 Clip & Spring Remover

Fits rubber clips, plastic clips & handle clips for removal of door panel & door handle. Also removes headlight springs.



DA6854

Windshield Locking Strip Tool

Double ended tips for inserting the locking strip around windshields & other windows on most cars. Features large comfort-grip handle. OL: 190mm.



DA6857

Clip Remover

Offset design easily removes door handles.



DA6858

Windshield Moulding & Door Handle Clip Tool

Heavy duty offset design easily removes door handles, windshield moulding clips, window cranks & trim pads. Vinyl-coated handles for comfort.



DA6862

Door Handle Clip Remover

Extra length & offset body for removal of internal handles. Reaches handle clip for instant removal without damage to upholstery.



DA6864

4pce Universal Windshield & Door Trim Tool Set

4 pce set for speeding up vehicle interior work. Releases windshield moulding on most vehicles. Removes window & door trim without damaging the paint & clips. Contains 3 in 1 clip spring remover, auto trim pad remover, moulding release tool and door handle clip remover.



Spot-Weld Cutters

Quality alloy steel double ended blade cuts perfect holes in most materials. Includes 1/4" arbour with retractable pilot assures accurate cuts. For use with all 1/4" or larger variable speed drills.

DA6865

5/16"

DA6866

3/8"



DA6867

Spot-Weld Cutter Set

Includes 5/16" & 3/8" spot-weld cutters. Quality alloy steel double ended blade cuts perfect holes in most materials. Includes 1/4" arbour with retractable pilot assures accurate cuts. For use with all 1/4" or larger variable speed drills.



DA6871

4pce Door Pin Extractor Kit

3 punches and handle for easy removal & installation of door hinge pins. Punch sizes: 3x110, 5x110 & 5.5x110mm.



DA6874

Door Pin Extractor - Replacement Pins

3 replacement pins for the DA6871.



Spot Weld Replacement Blades -3pce

DA6875

3pce 3/8" spot-weld cutter replacement blades for DA6866 & DA6867.



DA6878

3pce 5/16" spot-weld cutter replacement blade for DA6865 & DA6867.

DA6881

2pce Auto Body Pull-Rod Set

Repairs dents & creases from outside the car. One each of straight & formed shank picks/pulls to get between closely-shaped panels. Big grip handles for comfort.



DA6883

Windshield Remover - Replacement Blades

3 replacement blades for the DA6850 windshield remover.



DA6998

Telescopic Magnetic Pick-Up Tool with Needle

Multi-purpose needle, for spray nozzle cleaning and adjusting, line marking and sparkplug clean up. Magnetic tip for picking up small parts with telescopic end extending 150 to 670mm. Includes pocket clip.



DA6999

Telescopic Magnetic Pick-Up Tool with Scriber

Multi-purpose scriber. Telescopic magnetic tip for picking up small parts, extends from 150 to 670mm. Includes pocket clip.



DA7001

Flexible Pick-Up Tool

Flexible shaft bends and holds in all positions. Long & slender shaft for easy access in confined areas. Comfort-grip handle. OL: 510mm.



DA7002

Telescopic Magnetic Pick-Up Tool 0.5kg

Telescopic from 125-635mm. Magnetic capacity: 0.5kg. Stainless steel tool with pocket clip.



DA7003

Telescopic Magnetic Pick-Up Tool 1.6kg

Telescopic from 125-635mm. Magnetic capacity: 1.6kg. Stainless steel tool with pocket clip.



DA7004

Telescopic Magnetic Pick-Up Tool 2.2kg

Telescopic from 125-635mm. Magnetic capacity: 2.2kg. Stainless steel tool with pocket clip.



DA7005

Magnetic Pick-Up Tool 1.6kg

Telescopic from 300-720mm. Magnetic capacity: 1.6kg. Stainless steel tool with swivel ball joint head & pocket clip.



DA7008

2pce Adjustable Inspection Mirror Set

Features 2 mirrors. One telescopic mirror 175mm to 550mm. Another fixed length 205mm mirror. Both have a ball joint swivel head.

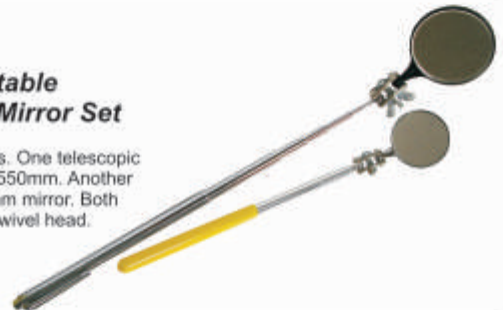

DA7013

Windscreen Spray Nozzle Needle

2 needles for adjusting and cleaning the windshield water outlets. Also helps correct spray direction. Compact size with pocket clip.



DA7016

Telescopic Inspection Mirror

Large mirror on ball joint swivel adapter for working in all angles. Handle is telescopic from 254mm to 356mm.



DA7040

Tweezer with Magnifier



DA7018

Stainless Steel Inspection Mirror

Stainless steel swivel mirror suits rough working areas. Handle is telescopic from 330mm to 710mm. Includes light.



DA7296

7pce Imperial Stubby Spanner Set

7pce imperial size spanners in a plastic case. Includes sizes: 3/8", 7/16", 1/2", 9/16", 5/8", 11/16" & 3/4".



DA7025

Pocket Telescopic Inspection Mirror

25 x 50mm oval mirror with ball joint swivel adapter. Handle with pocket clip extends from 184mm to 500mm.



DA7298

10pce Metric Stubby Spanner Set

10pce metric size spanners in a plastic case. Includes sizes: 10, 11, 12, 13, 14, 15, 16, 17, 18 & 19mm.



DA7026

Square Long Telescopic Inspection Mirror

Large 50x88mm square mirror with ball joint swivel adapter provides wider view. Handle extends from 330mm to 710mm.



DA7302

Flare Nut Spanner Set

Used in applications when access is impeded by such items as vacuum, hydraulic, refrigeration and fuel lines. Made from chrome-vanadium steel & heat treated. Extra thick to avoid damage to soft metal fittings. 10x12, 13x14 & 15x17mm sizes.



DA7302C

Flare Nut Spanner 13 x 14mm.

DA7027

Square Telescopic Inspection Mirror

Large 50x88mm square mirror with ball joint swivel adapter provides wider view. Handle is telescopic from 215mm to 490mm.

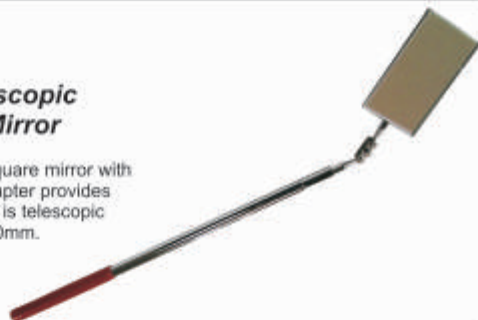

DA7313

10pce Torque Extension Bar Set

10 piece set allows for the easy application of proper torque to the wheel nuts while wheels are being replaced. It is critical to torque wheel nuts correctly to prevent damage to brake callipers, rotors and ABS brake system computers. 1/2" drive colour coded extension bars in the following torque ratings: 90Nm (65ft/lbs), 100Nm (75ft/lbs), 110Nm (80ft/lbs), 120Nm (90ft/lbs), 135Nm (100ft/lbs), 150Nm (110ft/lbs), 160Nm (120ft/lbs), 175Nm (130ft/lbs), 190Nm (140ft/lbs) & 200Nm (150ft/lbs).



DA7032

2pce Telescopic Mirror & Pick-Up Tool

Large 50mm diameter circular mirror provides wider view. Powerful magnet lifts 1.6kg. Both tools feature ball joints and telescopic handles for reaching into confined areas.



Torque Extension Bars

DA7330

90Nm (65ft/lbs)

DA7332

110Nm (80ft/lbs)

DA7334

135Nm (100ft/lbs)

DA7336

160Nm (120ft/lbs)

DA7338

190Nm (140ft/lbs)

DA7331

100Nm (75ft/lbs)

DA7333

120Nm (90ft/lbs)

DA7335

150Nm (110ft/lbs)

DA7337

175Nm (130ft/lbs)

DA7339

200Nm (150ft/lbs)

Each torque extension bar has a unique colour and is marked to identify its torque rating.



DA7356

Torque Angle Gauge

Measures angle of rotation after pre-torque load in torque-angle applications. Takes the guesswork out of tightening. Features 1/2" male & female square drives for both sockets and wrenches. 360 degree scale clearly marked in 2 degree increments & in intervals of 10 & 30. Easily zero the gauge by turning housing for next application.



DA7359

3/4" Drive Torque Wrench

3/4" square drive.
Torque range:
0-406Nm (0-300 ft/lbs).



DA7360

1/4" Drive Torque Wrench

1/4" square drive.
Torque range:
2.3-22.6Nm (20-200 in/lbs).



DA7361

3/8" Drive Torque Wrench

3/8" square drive.
Torque range:
5-80 ft/lbs



DA7362

1/2" Drive Torque Wrench

1/2" square drive.
Torque range:
0-203Nm (0-150 ft/lbs).



DA7363

1/4" Drive Ratchet Handle

1/4" square drive. 72 teeth ratcheting action allows operation in narrow spaces. Finger control disk provides you with one handed operation. Made from tempered alloy steel.



DA7364

3/8" Drive Ratchet Handle

3/8" square drive. 72 teeth ratcheting action allows operation in narrow spaces. Finger control disk provides you with one handed operation. Made from tempered alloy steel.



DA7365

1/2" Drive Ratchet Handle

1/2" square drive. 72 teeth ratcheting action allows operation in narrow spaces. Finger control disk provides you with one handed operation. Made from tempered alloy steel.



DA7366

3/8" Drive Torque Wrench

3/8" square drive.
Torque range:
2.3-22.6Nm (20-200 in/lbs)



DA8026

8 Metre Tape Measure

8 Metre / 26 feet long-lasting nylon protected power return blade in a highly visible tough plastic case.



DA9000

Gear Box Stop-Off

Graduated design fits most car's drive shaft. Plug to prevent spillage without draining gear box fluid when repairing drive shaft U-joints.



DA9008

Auto Computer Memory Tool

Maintains the memory of vehicle radios, clocks & computer functions while battery is disconnected. Simply attach a 9 volt battery & plug the tool into cigarette lighter. Keeps setting for up to 4 hours.



DA9027

Hydraulic Hose Pinch-Off Tool

For brake & fuel lines. Stops fluid with rounded clamp section to prevent damage to hose lining.



DA9031

Brake & Fluid Hose Clamp

Completely or partially closes brake or fuel lines with adjustable locking collar.



DA9032

Metal Bearing Packer

Handles all bearings with minimum 1/2" (13mm) I.D. to maximum 5" (125mm) O.D. and a height of up to 2" (50mm). Use with hand or power lube equipment making a messy job easy and correct packing of bearings.



DA9033

Universal Bearing Packer

Handles all bearings with minimum 1/2" (13mm) I.D. to maximum 5" (125mm) O.D. and a height of up to 2" (50mm). Use with hand or power lube equipment making a messy job easy and correct packing of bearings. Plastic Cones.



DA9035

Hose Pincher Set

Pinch-off vacuum, fuel & brake lines easily without damaging the line.



Hose Pinch Pliers

Special Radius jaws will not damage internal hose lining. Lightweight, non-conductive, bright-coloured. Small size for brake & fuel lines.

DA9036

Small Hose Pinch Plier

DA9037

Medium Hose Pinch Plier

DA9038

Heavy Duty Hose Pinch Plier Set

2 piece set with both small & medium size pliers.



DA9041

Large Hose Pinch Plier

Special Radius jaws will not damage internal hose lining. Lightweight, non-conductive, bright-coloured. Large size for radiator hoses.



DA9052

Truck Bearing Packer

Larger capacity for trucks or tractors. Handles all bearings up to 6-1/2" (165mm). Use with hand or powerful lube equipment making a messy job easy and correct packing of bearings.



Number Punch Sets

9 numbers 0 - 8. Numbers 6 & 9 use same punch. Made from hardened alloy steel available in a variety of punch set sizes.

DA9061

3mm Punches

DA9063

5mm Punches

DA9065

8mm Punches

DA9067

12mm Punches

DA9062

4mm Punches

DA9064

6mm Punches

DA9066

10mm Punches



Letter Punch Sets

26 letters A-Z. Made from hardened alloy steel available in a variety of punch set sizes.

DA9070

2mm Punches

DA9072

4mm Punches

DA9074

6mm Punches

DA9076

10mm Punches

DA9071

3mm Punches

DA9073

5mm Punches

DA9075

8mm Punches

DA9077

12mm Punches



DA9080

38 in 1 Letter & Number Punch Set

Click-type automatic punch tool stamps numbers & letters on metal, aluminium, brass, wood or plastic. Contains: 1 punch tool, 26 letters, 9 numbers 0-8 and one each of (&),(,).

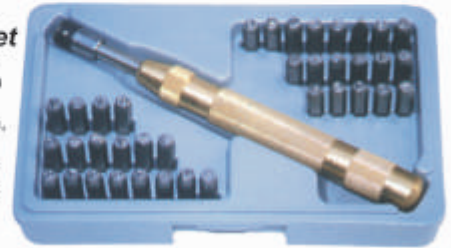

DA9081

3pce Brass Pin / Drift Punch Set

Non-sparking solid brass punches designed to prevent damage to the object being struck. Contains: 1/4" x 4" & 3/8" x 6" pin punches and 1/2" x 8" drift punch.



DA9082

3pce Brass Drift Punch Set

Heavy-duty punches for rough jobs. Non-sparking solid brass punches designed to prevent damage to the object being struck. Contains: 3/4" x 8" & 3/4" x 12" punches and 11/32" x 10" starter punch.



DA9083

2pce Solid Brass Punch Set

Non-sparking solid brass punches designed to prevent damage to the object being struck. Contains: an 8" x 3/4" drift punch and 8" x 5/8" starter punch.



DA9086

Punch & Chisel Holder

Grips punch or chisel shank of up to 25mm diameter. Makes control of punch or chisel easy & prevents missed strikes.



DA9090

Compression Tester Kit

Easy-to-read 2-1/2" diameter gauge features colour-coded quadruple calibrations with 0-300psi, 21 kg/cm, 21 bar & 2100 kpa. 13" durable rubber hose with 14mm/18mm adapter. 6" heavy-duty stem with universal rubber cone adapter fits all plug holes. Convenient pressure-holding side release valve. Provides an accurate reading on high performance engines.



DA9092

**Flex-Drive
Compression Tester**

Easy-to-read 2-1/2" diameter gauge features colour-coded quadruple calibrations with 0-300psi, 21 kg/cm, 21 bar & 2100 kpa. Long heavy-duty rubber hose with 14mm/18mm adapter.



DA9116

Pulley Remover & Installer Set

Properly replaces pressed-on power steering and alternator pulleys on Ford, Chrysler & late model GM engines. Reversible jaws for pulling & installing purpose. Set packed in convenient storage blow mould case.



DA9093

**Vacuum & Fuel
Pump Tester**

1-1/2" diameter gauge with colour coded scales. Extra-long heavy-duty rubber hose equipped with universal nose cone adapter. Easily locates leaks in fuel line, vacuum chokes, valve trouble or heating leaks.



DA9120

**Power Steering Pump
Puller Kit**

Kit contains everything necessary to remove & install pulleys on Saginaw, Thompson & Ford c111, C2 power steering pumps found on Ford GM & Chrysler vehicles. A disconnect tool to release the power steering line from pump on 1989-current GM pickups 1/2T,



DA9094

**Compact
Compression Tester**

1-1/2" diameter gauge features colour-coded quadruple calibrations with 0-300psi, 21 kg/cm, 21 bar & 2100 kpa. Durable universal rubber cone adapter fits all plug holes. Handy press-on type checks for worn or defective rings, pistons, valves & cylinders.



DA9123

**Balancer, Puller &
Installer**

A professional tool set for balancer replacement. Built-in bearing makes balancer replacement job easy & damage free. 4-slot puller plate plus 4 threaded adapters fit to balancers on most engines.



DA9095

**Steering Wheel Holder &
Pedal Depressor Kit**

Has a trigger-controlled mechanism and thumb lock release. This brake & accelerator depressor is designed to use against the front of the car seat to obtain leverage.



DA9130

AF Clutch Alignment Tool

Align single disc clutches on most vehicles, light trucks & tractors. Properly aligns clutch plate by tapered cone fitting into clutch hole & adapter fitting through clutch plate & into pilot bushing or bearing. Set contains shaft & 1 1/16" & tapered cone plus 8 2 stepped pilot bearing adapters (16 sizes).



DA9110

**Harmonic Balancer
Installer**

Installs harmonic balancers or drive pulleys that are pressed on camshaft. 8 adapters: 7/16"-20, 1/2"-20, 9/16"-18, 5/8"-18, 3/4"-16, M12x1.5, M14x1.5 & M16x2.0.



DA9131

20pce Bushing Set

Set includes 3 drivers with nuts, storage case & 16 adapters from 3/8" to 1-3/8" (9.5 - 35mm).



DA9115

Pulley Bracing Tool

Ideal for bracing when removing or replacing any type of grooved pulleys, also can rotate the cam shaft when timing the engine. Also removes oil & fuel filters.



DA9132

**17pce Universal Clutch
Alignment Tool**

16 SAE & Metric pilot bearing adapters serve most alignments of clutch plate for assembly on cars: Audi, Opel, Fiat, Honda, Citroen, Mazda, Nissan, Mitsubishi, Peugeot, Renault, Rover, Saab, Vauxhall, Toyota, Volvo & VW.



DA9134

Metric Clutch Alignment Tool

Aligns most metric clutch plates with 10 pilot bushings and 2 plate alignment cones in sizes: 12, 12.6, 14, 15, 15.8, 16, 17, 18, 19, 20mm plus graduated turned diameters cone & tapered cone.



DA9135

Bushing Extractors

Remove bushings from all types of transmissions and housings. Two extractors will accommodate bushing sizes from 7/16" to 1-1/2" I.D. Use with 1/2" UNC or 5/8"-18 side hammer, the threaded adapter is included.



DA9137

Seal Driver Kit

One drive handle and 16 adapters drive seals quickly without damage to parts. Includes special adapters for shielded seals.



DA9139

10 pce Bearing Race & Seal Drive Kit

Quickly & easily inserts wheel bearing races & seals without damage to race & axle housing. 9 disc sizes fit most standard wheel bearings. The other side of disc can drive seals evenly. Disc sizes: 1.565", 1.75", 1.965", 2.325", 2.47", 2.555", 2.83", 2.995" & 3.18".

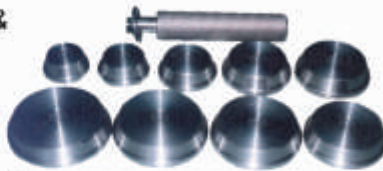

DA9141

7pce Bearing Race & Seal Drive Kit

Aluminium driving handle & 6 discs fit most popular bearing racers in sizes: 1.565", 1.75", 1.965", 2.325", 2.47" & 2.555". Easily inserts the bearing race & helps reduce damage to both race & axle housing. Drives seals with other side of disc.

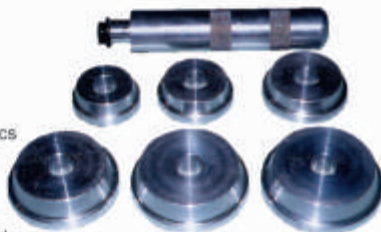

DA9178

10pce Screw Extractor Kit

Contains five spiral extractors #1 through #5 and five mechanics length HSS drills. Removes bolts and screws up to 5/8". Left hand extractors with right hand drills. Contains HSS drill sizes: 5/64", 7/64", 5/32", 1/4" & 19/64". Screw extractor sizes 5/64", 7/64", 5/32", 1/4" & 19/64".



Dead Blow Hammers

Dead-blow hammers are made from oil and cold resistant SBR materials. Their hollow heads contain steel particles that prevent rebound and apply greater force by providing a second blow.

DA9301

30 mm diameter, 80 mm long blow head. 350g

DA9303

45 mm diameter, 90 mm long blow head. 580g

DA9305

55 mm diameter, 110 mm long blow head. 1050g

DA9307

65 mm diameter, 130 mm long blow head. 1540g

DA9309

105 mm diameter, 200 mm long blow head. 5500g

DA9302

35 mm diameter, 90 mm long blow head. 400g

DA9304

50 mm diameter, 100 mm long blow head. 775g

DA9306

60 mm diameter, 120 mm long blow head. 1230g

DA9308

80 mm diameter, 180 mm long blow head. 4500g



DA9401

6" Magnetic Stainless Steel Tray

6" magnetic circular tray grabs bolts, nuts, screws, nails, washers and other components even if tray is upside down.



DA9404

Magnetic Stainless Steel Tray

9-3/8" x 4-3/8" tray. Features two 3-1/4" heavy-duty magnets to grip ferrous metal surfaces for strong holding power. Holds tools & parts. Even works upside down.



DA9411

Hands-Free Work Light

Perfect for automotive, electrical and plumbing jobs or for roadside & household emergencies. Worn like glasses, with a pair of miniature floodlights powered by 4 AAA batteries (not included).



Spanner Racks

Durable plastic spanner rack for wall mounting.

DA9412

Holds 12 spanners

DA9413

Holds 15 spanners



Safety Wire Twist Plier

The wire twist pliers have automatic spring return and feature a right hand twist. Made from forged alloy steel, tapered jaws for easy access to confined areas, mated cutting edges to cut safety wire to 1/16" diameter and a long life mechanism. 225mm OAL.

DA9469

OL: 225mm

DA9470

OL: 170mm



DA9416

2pce Stripped Screw Remover Set

Phillips and slotted screwdrivers ingeniously designed to remove screws with damaged heads. Special tips designed for tapping into screw head with a hammer and then turn to remove the screw. Tool can be used as a regular screwdriver.



DA9418

Quarter Turn Driver

Snap-on handle & specially designed wide slotted blade for removing quarter-turn type fasteners used in automotive & aircraft applications.



Industrial Groove Joint Pliers

Drop forged chrome vanadium steel & hardened. Machine rib & groove joint securely locks into place. Heavy-duty cushion-grip handle provides a firm and comfortable grip.

DA9471

OL: 8"

DA9472

OL: 10"

DA9473

OL: 12"



DA9419

Pneumatic Panel Crimper

For use with air hammer, 180mm OL alloy steel tool with safety handle grip for forming & patching sheet metal.



DA9426

2pce Stripped Screw Remover Set

Phillips and slotted screwdrivers ingeniously designed to remove screws with damaged heads. Special tips designed for tapping into screw head with a hammer and then turn to remove the screw. Tool can be used as a regular screwdriver.



Mechanic's Combination Pliers

Hardened drop forged chrome vanadium steel. Perfectly mated cutting edge and heavy-duty comfort-grip handles.

DA9476

OL: 6"

DA9477

OL: 7"

DA9478

OL: 8"



DA9467

Ratchet Crimping Tool

Heavy gauge steel construction for insulated terminals red, blue & yellow. For wire sizes: AWG 22-18, 16-14, 12-10 (mm x mm 0.5-1, 1.5-2.5, & 4-6). Ratcheting action & leverage handle makes crimping jobs fast and easy.



Industrial Long-Nose Pliers

Hardened drop forged chrome vanadium steel. Mated jaws offer a reliable firm grip on your work. Long jaws for confined areas. Heavy-duty comfort-grip handles.

DA9480

OL: 6"

DA9481

OL: 8"



DA9483

7" Heavy-Duty Diagonal Cutting Plier

Hardened drop forged chrome vanadium steel. Heavy-duty comfort-grip handles. 7" OL.



Diagonal Cutting Pliers

Hardened drop forged chrome vanadium steel. Hand-honed cutting edges. Heavy-duty comfort-grip handles.

DA9485

OL: 6"

DA9486

OL: 7"



Curved Long-Nose Pliers

Designed for hard-to-reach tight spaces. Drop forged chrome vanadium steel. Perfectly mated jaws with no side wobble provide you with a strong reliable grip on your work. Heavy-duty comfort-grip handles.

DA9487

OL: 6"

DA9488

OL: 8"



Professional End-Cutting Pliers

Drop forged chrome vanadium steel. Hardened hand-honed cutting edges for easiest cutting. Heavy-duty comfort-grip handles.

DA9490

OL: 6"

DA9491

OL: 8"



DA9492

6" Duck Bill Plier

Excellent for use in restricted & recessed areas. Extra long noses & fine serrated jaws for firm gripping. Made from alloy steel & hardened. Heavy-duty comfort-grip handles. 6" OAL.



Aviation Snips

Drop forged chrome-moly steel blades. Cuts up to 18 gauge cold rolled steel.

DA9493

Left Cut Aviation Snips



DA9494

Straight Cut Aviation Snips



DA9495

Right Cut Aviation Snips



DA9560

Mechanics Stethoscope

Sensitive instrument for accurate & fast location of trouble in engines and other moving parts.



DA9561

Mechanics Stethoscope

Plastic ear plugs shut out outside noise. Aluminium sound chamber amplifies even the lowest sounds through a rubber-mounted probe, locating trouble in engines before internal damage occurs.



DA9562

Electronic Stethoscope

Listen for irregularities in engines to diagnose problems. Includes microphone on flexible shaft, headphones, volume control and 9 volt battery.



DA9609

Magnetic Screwdriver & Retriever

The screwdriver has a telescopic pickup tool hidden in it's hollow shank. Features a non-slip rubberised handle with 7 useful bits.



DA9610

4 in 1 Stubby Screwdriver

Features easy grip handle & reversible bits kept in handle. The stubby driver works in tiny corners. Bit sizes: slotted 5 & 6mm & Phillips #1 & #2.



DA9623

T-Handle Screwdriver

Gearless ratcheting design provides a smooth action & most importantly, high torque on every application. Includes 6 bits, slotted 5 & 6mm, Phillips #1 & #2.



DA9615

Insulated Screwdriver Set

Each screwdriver protects against up to 1000 volts of electricity. Set contains: Phillips #0, #1 & #2 and slotted 1/8", 5/32", 7/32" & 1/4".



DA9624

6 in 1 Screwdriver with Light

The inbuilt light illuminates dark areas while you work. 6 useful bits stored inside the handle include: slotted 5 & 6mm, Phillips #1 & #2 and Pozi #1 & #2.



DA9617

7pc Industrial Nut Driver Set

Large colour-coded non-slip handles for sturdy, comfortable grip. Hollow shanks allow easy access to tight areas & greater bolt clearance. Hardened 6 point sockets. 7 piece set includes SAE 3/16", 1/4", 5/16", 11/32", 3/8", 7/16", 1/2" Metric 6, 7, 8, 9, 10, 11, 12mm drivers.



DA9625

7 in 1 Screwdriver with Light

The inbuilt light illuminates dark areas while you work. Also features a telescopic retriever hidden in the handle. 6 useful bits stored inside the handle include: slotted 5 & 6mm, Phillips #1 & #2 and Pozi #1 & #2.



DA9618

20 in 1 Screwdriver Set

10 double-ended alloy steel blades feature 20 most popular and useful sizes. Rubberised non-slip handle. Includes: slotted 4, 5, 6 & 7mm, Phillips #1 & #2, Pozi #1 & #2, ball hex 4, 5 & 6mm, Hex 4, 5 & 6mm and Torx® T10, 15, 20, 25, 30 & 40.



DA9629

Speed Screwdriver & Hand Drill

Bearing-like drive handle allows turning like a hand drill. Comes with a drill bit & one double ended reversible blade for simple drill and screw driving jobs.



DA9620

24pc Screwdriver & Socket Set

A universal kit to be used by manual or cordless power driving tools. Set includes ratchet driver handle, flexible extension bit holder, 9 sockets, socket adapter, 8 bits & magnetic pickup adapter. Comes in convenient blow-mould case.



DA9630

Multi-Function Screwdriver

Screwdriver, plus flexible extending all in one tool. Includes: slotted 5, 6 & 7mm and Phillips #1, #2 & #3. 14". (360mm) OL when extended.



DA9621

4pc Stubby Screwdriver Set

The super-short drivers reach into areas so small even regular stubby screwdrivers don't fit. Includes: slotted 5 & 6mm and Phillips #1 & #2.



DA9631

8pc Insulated Screwdriver Set With Circuit Tester

Each screwdriver protects against up to 1000 volts of electricity. Set contains: Phillips #0, #1 & #2, slotted 1/8", 5/32", 7/32" & 1/4" and a circuit tester.



DA9650

Professional Impact Driver Set

Professional quality made from chrome-moly steel, heat treated & chrome plated. Convert impact from a hammer to a powerful torque for loosening screws, nuts & bolts when rusted or wedged tight. Includes hammer driver & 4 bits: 36mm long Phillips #2 & #3 and



DA9820

Paint Strainer

Reusable copper network to strain particles from lacquer, varnish, enamel, solvents, oils, etc. Prevents undissolved pigments from spoiling paint jobs. Total filtration for true colour match, a fast method of straining all types of paint. Spring clip locks into fluid tubes on all major paint guns.



DA9927

Interchangeable Lead More Hammer Set

Save space, weight, money and time. Great for: panel beating, metal work & craft works. 8 hammer bit pieces including: cross curve, ball peen, ball type, small curve, angle groove, round face, square face & multi-curve.



DA9929

Chisel & Punch Set

Includes strong handle. 12pce chrome-vanadium set: 13, 16, 19, 22 & 25mm (wide) flat chisels, 6mm (wide) cap chisel, 3 & 6 mm (diameter) taper punches, 5 & 6mm (diameter) pin punches and 3 & 5mm (diameter) centre punches.



DA9985

50pce O-Ring Assortment Kit

50 piece set containing 12 of the most commonly used sizes for your sealing applications. Made of nitrile rubber.





A **AUTOMOTIVE TOOLS**

S **SPECIALTY TOOLS**

I **INDUSTRIAL TOOLS**

Abridged Trading Terms & Conditions

Catalogue and Prices:

Whilst Endeavour Tools Pty. Ltd. has exercised care in the preparation of its catalogues and price lists it reserves the right to correct any errors or omissions. Endeavour Tools Pty. Ltd. Also reserves the right to amend prices due to circumstances beyond its control. Please refer to the current price list for price details.

Handling Charge:

A handling charge applies to orders less than our minimum free into store value.

Return of goods:

Goods supplied as per customer's order cannot be accepted for return or exchange without a "return for credit authorization number". Unless by prior agreement in writing a re-stocking fee of 15% will apply. Goods must be new and in a re-saleable condition. Goods are to be returned "freight paid".

Claims for damage in transit, short delivery or non-delivery:

Claims for these matter will not be accepted unless made within 7 days from receipt of goods, or, in the case of non-delivery, within 7 days of an order being placed.

Payment:

Nett cash 30 days from date of statement.

Reservation of title:

All orders are accepted & supplied according to our terms & conditions of trade and there is a retention of title and lien on monies until all debts owed by the purchaser to the company are paid for in full. For full conditions of sale see Terms and Conditions of sale re-issued May 2002.

Specifications:

Endeavour Tools Pty. Ltd reserves the right to change, without notice specifications shown in any catalogue or other media

Warranty:

AP Tools brand of products that are faulty due to defective materials or faulty workmanship, will, at the discretion of Endeavour Tools Pty Ltd be either repaired or replaced. Any item which is claimed as a warranty is to be returned, freight prepaid to Endeavour Tools Pty Ltd. A warranty will not apply if the tool has been abused, used for a purpose other than which is intended, or the fault is due to fair wear and tear. Endeavour Tools Pty Ltd reserves the right to require evidence of purchase to support a claim for warranty on an item. Note: A limited warranty may apply on some items - where this is the case this will be clearly shown.

ENDEAVOUR TOOLS PTY LTD

VICTORIA - Head Office
50 Jellico Drive
Scoresby VICTORIA 3179
Phone: (03) 9753 3800
Fax: (03) 9753 3933

SYDNEY
Suite 1 / Unit 2,
12-18 Victoria Street East
Lidcombe NSW 2141
Phone: (02) 9646 4222
Fax: (02) 9646 5399

from **ENDEAVOUR TOOLS**



Your **AP TOOLS** Distributor

from  **ENDEAVOUR TOOLS**